

INBOARD PLAN VIEW

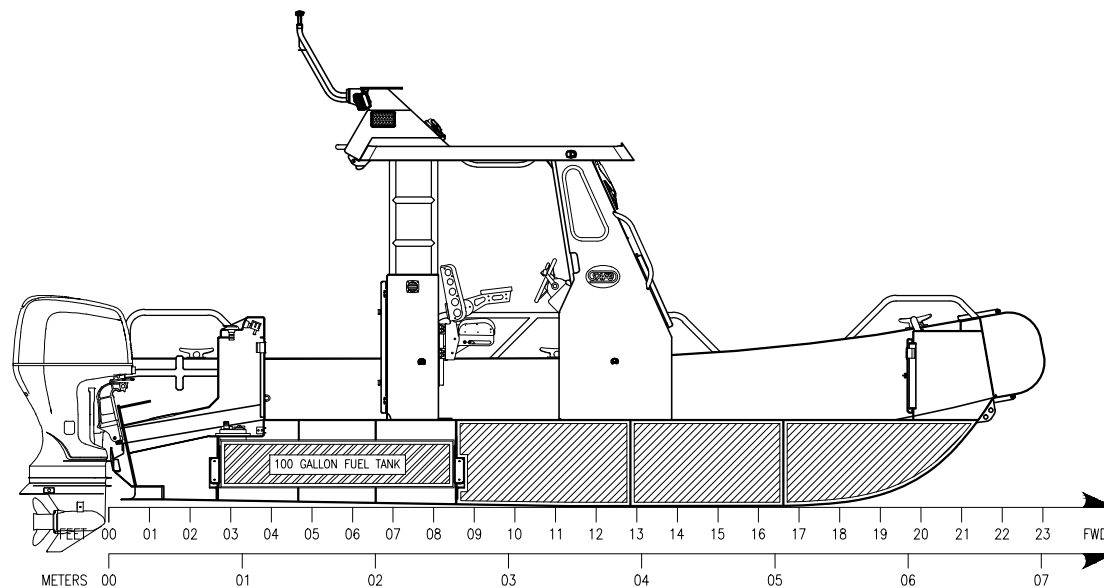

INBOARD PROFILE

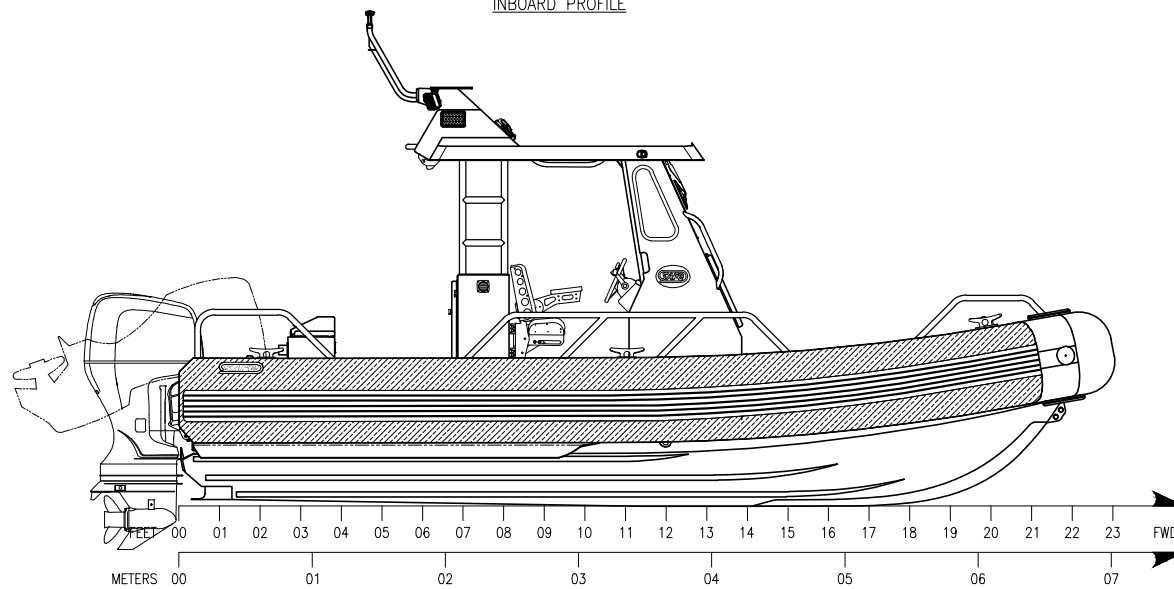

OUTBOARD PROFILE

SPECIFICATIONS

LOA	23' [7.0]
BEAM	8'-6" [2.6]
HEIGHT ON TRAILER	11'-6" [3.5]
DEADRISE	25"
FUEL	100 GALLONS [378 LITERS]
MAX HP	400 [294.2 kW]

SHOWN WITH OPTIONAL ENGINES. SPECIFICATIONS ARE APPROXIMATES ONLY AND SUBJECT TO CHANGE.

THIS DOCUMENT DISCLOSES SUBJECT MATTER IN WHICH SAFE BOATS INTL., LLC. HAS PROPRIETARY RIGHTS. THE INFORMATION AND DESIGN DISCLOSED HEREIN WERE ORIGINATED BY AND ARE THE PROPERTY OF SAFE BOATS INTL., LLC. NEITHER RECEIPT NOR POSSESSION THEREOF CONFERS ANY RIGHT TO REPRODUCE, COPY, OR DISCLOSE THE DOCUMENT, ANY PART THEREOF, ANY INFORMATION CONTAINED THEREIN OR TO CONSTRUCT PRODUCTS FROM IT.



GENERAL ARRANGEMENTS

SAFE BOATS DRAWING NO.	REV
223- SAFE 23 CENTER CONSOLE	-
SCALE: NONE	SHEET 1 OF 1