



PONTOON OWNER'S MANUAL

CRESTLINER BOATS

609 13th Ave N.E.
Little Falls, MN 56345

Crestliner
Pontoon Owner's Manual

Model/Number: _____

Dealer Name _____

Hull Identification Number: _____

Address _____

Date of Ownership: _____

Phone # _____

Crestliner reserves the right to change, alter, and modify their finished boats, parts, and specifications included in your Owner's Manual without notice. Optional equipment described in this manual may vary from model to model and year to year. Please consult with your Crestliner Dealer for current information on standard and optional equipment and specifications.

This manual has been compiled to help you operate your craft with safety and pleasure. It contains details of the craft, the equipment supplied or fitted, its systems, and information on its operation and maintenance. Please read it carefully and familiarize yourself with the craft before using it.

If this is your first craft, or if you are changing to a type of craft you are not familiar with, for your own comfort and safety, please ensure that you obtain handling and operating experience before "assuming command" of the craft. Your dealer will be pleased to advise you of local schools or competent instructors.

PLEASE KEEP THIS MANUAL IN A SECURE PLACE, AND HAND IT OVER TO THE NEW OWNER WHEN YOU SELL THE CRAFT.

Table of Contents

LINE DRAWINGS	i	PRE-LAUNCH & UNDERWAY (CONT.)	3
WELCOME ABOARD	1	Getting Underway	3.10
Owner's Manual Structure.....	1.1	Controls.....	3.11
Responsibilities	1.2	Starting Procedures	3.12
Pontoon Records	1.3	Trimming	3.14
Warranty.....	1.3	Additional Underway Information	3.15
Crestliner Pontoon Log (Form).....	1.4	Engine Shut Down	3.16
Crestliner Cruise Log (Form)	1.5	Reloading Your Pontoon.....	3.16
Crestliner Fuel Usage Log (Form).....	1.6	MAINTENANCE	4
Navigational Aids Chart	1.8	Service & Maintenance Schedule	4.1
Boating Safety.....	1.9	CARE & APPEARANCE	5
Safety Underway	1.12	Tube and Fence Care.....	5.1
Weather	1.15	Upholstery.....	5.2
Safety Equipment.....	1.16	Windshields and Windows	5.2
Additional Recommended Equipment.....	1.18	Carpeting	5.3
Boating Laws & Regulations	1.18	Canvas.....	5.3
Illegal to Dump	1.19	WINTERIZATION & STORAGE	6
SYSTEMS & COMPONENTS	2	Prior to Storage.....	6.1
Safety Labels	2.1 - 2.2	Engine.....	6.1
Systems	2.3	Livewell	6.2
Equipment.....	2.5	Interior Cleaning.....	6.2
Livewell	2.8	If You Store Your Pontoon on a Trailer	6.3
Seating.....	2.9	Recommissioning.....	6.3
Troubleshooting.....	2.10	PONTOON TERMINOLOGY	7
PRE-LAUNCH & UNDERWAY	3		
Trailerage	3.1		
Launching	3.2		
Loading.....	3.4		
Anchoring.....	3.6		
Fueling Recommendations	3.6		

Congratulations on the purchase of one of the finest aluminum pontoons in the world. It has been proudly built to give you many years of boating pleasure.

We've done our part—

Pride of craftsmanship is your assurance that you've bought the very best. All Crestliner Pontoon Boats meet or exceed U.S. Coast Guard safety standards relating to load and horsepower capacity, flotation, electrical, steering, ventilation, and fuel systems, in effect the date of manufacture.

But our work is not over—

We stand behind every pontoon we build. Your Crestliner dealer will assist you with registration of your pontoon for warranty. They will be happy to help you maintain your pontoon and answer questions concerning warranty, performance, accessories, and service. The warranty card must be filled out and sent to establish your warranty.

Now it's your turn—

This Owner's Manual is intended to help you become familiar with your new pontoon. While this manual contains information to assure safe and enjoyable boating, it does not provide everything you need to know. Above all, take time to know your pontoon. Read the material supplied by the manufacturer of your engine, and other pontoon components. *This owner's manual does not supersede or change any of their specifications, operation, or maintenance instructions.* Also read all literature supplied with your pontoon by the manufacturers of the various accessories which are used on your pontoon. Crestliner recommends that you read the boating literature published by your State Boating Agency and the U.S. Coast Guard.

OWNER'S MANUAL STRUCTURE

Use your owner's manual as a guide to familiarize yourself with the systems and components on board your Crestliner pontoon. The procedures in this manual will assist you with safe and proper operation, and maintenance of your pontoon. The level of information may be general in some cases and more detailed in others.

Suppliers of the more complex components such as engine, electronics, and pumps, supply their own instructional manuals delivered to you when you purchased your pontoon. These suppliers maintain their own manufacturer's warranty and service facilities. It is essential that you fill out each warranty card and mail them to each manufacturer informing them that you are a registered owner of their product(s). Record all information regarding these products on the "Pontoon Log" located in this chapter under Pontoon Records. Keep the Pontoon Log in a safe place at home and never on board the pontoon.

Your owner's manual is designed with the pontoon owner/operator in mind. The intent of the manual is to provide sufficient information to allow the user to safely operate and maintain your new Crestliner Pontoon Boat. Your Pontoon Owner's Manual is structured as follows:

WELCOME ABOARD

Included in the Welcome Aboard Chapter of your manual is our welcome aboard message to all new Crestliner Pontoon Boat owners, construction and standards, dealer and owner responsibilities, warranty, important logs and this summary of your owner's manual.

The Safety portion of this chapter contains safety recommendations, safety information and practices, weather precautions, and safety equipment (on board and underway). Additionally, specific safety warnings and comments are located throughout your owner's manual (and on your pontoon), therefore you should carefully read the entire manual.

SYSTEMS & COMPONENTS

The Systems & Components Chapter provides illustrative information on items such as the fuel system, porta potti, livewell, and other components installed on your pontoon.

PRE-LAUNCH & UNDERWAY

The intent of the Pre-launch & Underway Chapter is to familiarize the pontoon owner/operator with necessary information in preparation of trailering, launching and putting your new pontoon in the water. Encountering underway adjustments and situations is also explained.

MAINTENANCE

Recommendations for keeping your new pontoon in sound operational condition, making adjustments, and frequency of checks and inspections are all introduced in the Maintenance Chapter.

CARE & APPEARANCE

Provided in the Care & Appearance Chapter are inspections, cleaning, and maintenance for your pontoon.

WINTERIZATION & STORAGE

The Winterization & Storage Chapter presents information and procedures to follow when your pontoon will be winterized or stored for extended periods of time.

BOATING TERMINOLOGY

Terms and definitions associated with your pontoon that you will encounter while participating in recreational boating can be found in the Boating Terminology Chapter.

RESPONSIBILITIES

Pontoon Owner

1. Set up an appointment with your Crestliner dealer to discuss all warranties. Complete and return the Warranty Registration card, and keep a record of the hull number for future reference.
2. Inspect the pontoon at the time of delivery to verify that all systems and components are operating safely and acceptably. Read all manuals and instructions.
3. Operate all equipment in compliance with the manufacturer's instructions.
4. Schedule an appointment with your dealer to spell out the pre-delivery engine service record. Sign this record to indicate that it has been explained to you in detail by your dealer.
5. Schedule with your dealer your pontoon's 20 hour check-up.

IMPORTANT: (Stern drive only) Make sure that your dealer checks the engine alignment during your pontoon's 20 hour check-up. The engine alignment check should be per-

formed in accordance with the recommended procedures as stated by the engine manufacturer in your engine owner's manual. Failure to do so could result in drive train damage and is not covered under the Crestliner Warranty.

6. Reference your engine warranty certificate for initial inspection and service requirements.
7. Perform or provide for the warranted periodic maintenance outlined in this manual and all related service guides and manuals.

Crestliner Dealer

1. Your Crestliner dealer will discuss the terms of all warranties, and emphasize the importance of registering each warranty with the appropriate manufacturer.
2. Your dealer will provide instruction for obtaining warranty service.
3. Your dealer will cover each item on the pre-delivery service record with you, and then sign it to certify that all work has been suitably performed.
4. Your dealer can provide you with a comprehensive instruction in the operation of your pontoon and all systems and components installed on board, just ask your dealer.

PONTOON RECORDS

You have been provided with three very useful forms at the end of this section. The **Pontoon Log** is used to write down all of your pontoon's important information and data regarding the major components installed on your pontoon. Once you have entered all the information, remove the Pontoon Log from your Owner's Manual and keep it in a safe place. **Do not** keep this log on board your pontoon.

The purpose of the **Cruise Log** is to provide a record of your destination, departure and return times, pontoon description, passenger list, and other information regarding your trip expectations. At the bottom of the log is a place to list emergency telephone numbers in case you encounter trouble underway and your return time has expired.

The **Cruise Log** is to be photocopied, filled out, and left ashore with a responsible person. In the event of an emergency, this log is to be reported to the proper authorities. The person reporting this information should list their name, location, and telephone number on the Cruise Log. You should make several copies of this log to use throughout the pontooning season.

The **Fuel Usage Log** is an easy way to log information covering engine hours, fuel consumption, miles traveled, RPMs, Average MPH, and GPH (gallons per hour). Observance of the information logged will forewarn you of scheduled maintenance and inspections.

WARRANTY

Your new pontoon is backed by a Limited Warranty. Being aware of its terms is important. If a problem arises with your pontoon as a result of workmanship or materials, contact your dealer as soon as possible to determine if it may be covered by the warranty. Please have your hull identification number, and necessary model numbers on hand for the items that require service or repair. Your hull identification number is located below the rub rail on the starboard rear corner of your outboard pontoon, or on the transom of stern drive pontoon.

CRESTLINER PONTOON LOG

Purchase Dealership

Name _____ Sales Manager _____
 Address _____ Phone _____
 _____ Fax _____

Service Dealership

Name _____ Service Manager _____
 Address _____ Phone _____
 _____ Fax _____

General

Model Name _____ State of Registration _____
 Hull Identification Number _____
 Pontoon Name _____
 Hull Color(s) _____
 Length _____ Beam _____ Weight _____
 Draft (Drive Down) _____ Draft (Drive Up) _____
 Freeboard (Fore) _____ Freeboard (Aft) _____

Engine

Manufacturer _____ Model Name/Number _____
 Oil Type/SAE _____ Quarts _____ Filter Type _____
 Serial Number _____ Transom Plate Serial Number _____

Drive Unit

Serial Number _____

Fuel System

Tank Capacity _____ Filter Type _____

Propeller

Manufacturer _____ Pitch _____

Battery

Manufacturer _____
 Model Number _____

Radio

Manufacturer _____ Type _____

Model Number _____

Serial Number _____

Key Numbers

Cabin _____

Glove Box _____

Ignition _____

Additional Equipment

CRESTLINER CRUISE LOG

Complete this page before going boating and leave it with a reliable person who can be depended upon to notify the Coast Guard or other rescue organization should you not return as scheduled.

Do not file this plan with the Coast Guard.

Name and phone number of person on shore with whom this form has been filed _____

Automobile License _____

Type _____ Trailer license _____

Color _____ and make of auto _____

Where parked _____

Trip Information

Departure Date/Time _____ Departure Location _____

Destination(s) _____

Destination(s) _____

Destination(s) _____

Pontoon Description

Pontoon Name _____ Type _____

Crestliner

State Registration Number _____ Manufacturer _____

Length _____

Hull Color(s) _____ Deck Color(s) _____

Cabin (Color) _____ Trim (Color) _____

Other Physical Characteristics _____

Persons aboard _____

Name _____ Age _____ Address & Telephone No. _____

Captain: _____

Do any of the persons aboard have a medical problem?

Yes No If yes, what? _____

Engine

Type _____ HP _____

Fuel Type _____ Fuel Capacity _____

Safety & Emergency Equipment (YES/NO & NUMBER)

Life Jackets _____ Cushions _____ Distress Light _____

Flares _____ Smoke Signals _____ Flashlight _____

Mirror _____ Paddles _____ Anchor _____

Food _____ Water _____ Life Raft _____

Radio

On board (Yes/No) _____ Type _____

Frequencies usually used or monitored _____

The boat listed below should return by:

_____ Date _____ Time _____
at the latest. If it has not, please call the emergency numbers listed below.

Police _____

Coast Guard _____

Other Authority _____

Personal _____

Passenger List (Use Another Sheet If Necessary)

Full Name _____

Age/Sex _____ Phone Number _____

Complete Address _____

Full Name _____

Age/Sex _____ Phone Number _____

Complete Address _____

Full Name _____

Age/Sex _____ Phone Number _____

Complete Address _____

Full Name _____

Age/Sex _____ Phone Number _____

Complete Address _____

ALWAYS FILL THIS SHEET OUT COMPLETELY—IN AN EMERGENCY ALL INFORMATION MAY BE HELPFUL

CRESTLINER FUEL USAGE LOG

Date	Run Time (In Hours)	Fuel Used (In Gallons)	Distance Traveled (In Miles)	RPM	Average Miles per Hour	Gallons per Hour

Date	Run Time (In Hours)	Fuel Used (In Gallons)	Distance Traveled (In Miles)	RPM	Average Miles per Hour	Gallons per Hour

Explanation of Safety Labels

The most important aspect of boating is safety. Although every effort is made to address the numerous issues regarding the safe usage of your pontoon, it is strongly recommended that you avail yourself of the training and knowledge available through boating safety courses, etc.

Warning Labels

Mounted at key locations throughout your pontoon are warning labels which advise the owner/operator of imperative safety precautions to follow when operating and/or servicing equipment.

The examples below indicate the level of hazard by color and explanation.

 **DANGER**

Denotes an immediate hazard exists that **WILL** result in severe personal injury or death.

 **WARNING**

Denotes hazards or unsafe practices that **COULD** result in severe personal injury or death.

 **CAUTION**

Denotes hazards or unsafe practices that **COULD** result in minor personal injury, product or property damage.

NOTICE

Denotes information that is important to know prior to operation and/or maintenance, but is not hazard related.

Safety Precautions

The precautions below appear throughout this manual and must be observed when operating or servicing your pontoon. Learn to recognize the degree of precaution and understand the explanations of safety prior to reading this manual. These precautions are not all-inclusive. Always use common sense in the operation of your pontoon.

 **DANGER**

Denotes an immediate hazard exists that **WILL** result in severe personal injury or death.

 **WARNING**

Denotes hazards or unsafe practices that **COULD** result in severe personal injury or death.

 **CAUTION**

Denotes hazards or unsafe practices that **COULD** result in minor personal injury, product or property damage.

NOTICE

Denotes information that is important to know prior to operation and/or maintenance, but is not hazard related.

NAVIGATIONAL AIDS CHART

REMEMBER THESE RULES

- OVERTAKING - PASSING:** Boat being passed has the right-of-way. **KEEP CLEAR.**
- MEETING HEAD ON:** Keep to the right.
- CROSSING:** Vessel on right has the right-of-way. **Slow down and permit boat to pass.**

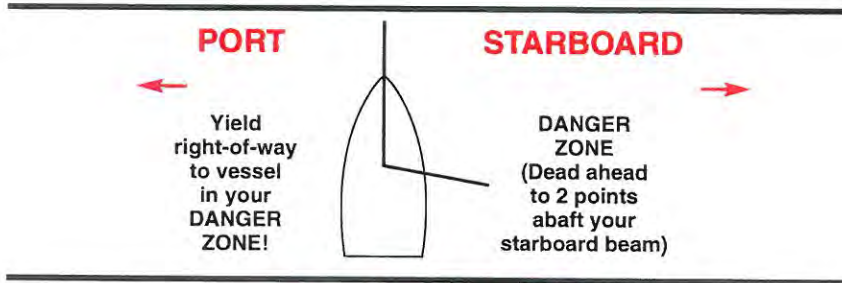

WHISTLE SIGNALS

- ONE LONG BLAST:** Warning signal (Coming out of slip)
- ONE SHORT BLAST:** Pass on my port side
- TWO SHORT BLASTS:** Pass on my starboard side
- THREE SHORT BLASTS:** Engine(s) in reverse
- FOUR OR MORE BLASTS:** Danger signal

BRIDGE SIGNALS

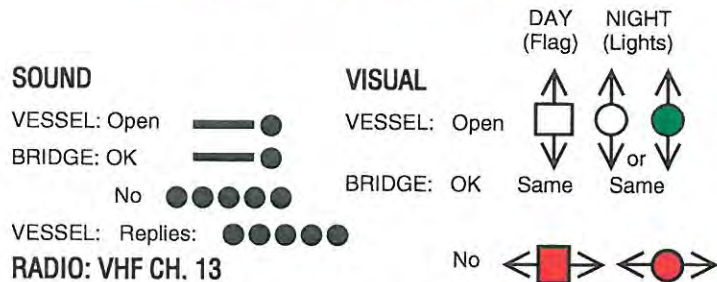

STORM WARNINGS

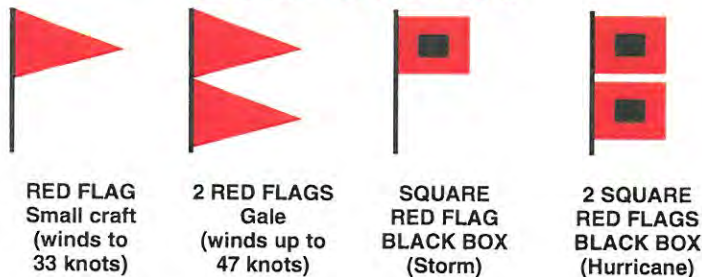

LATERAL AIDS AS SEEN ENTERING FROM SEAWARD

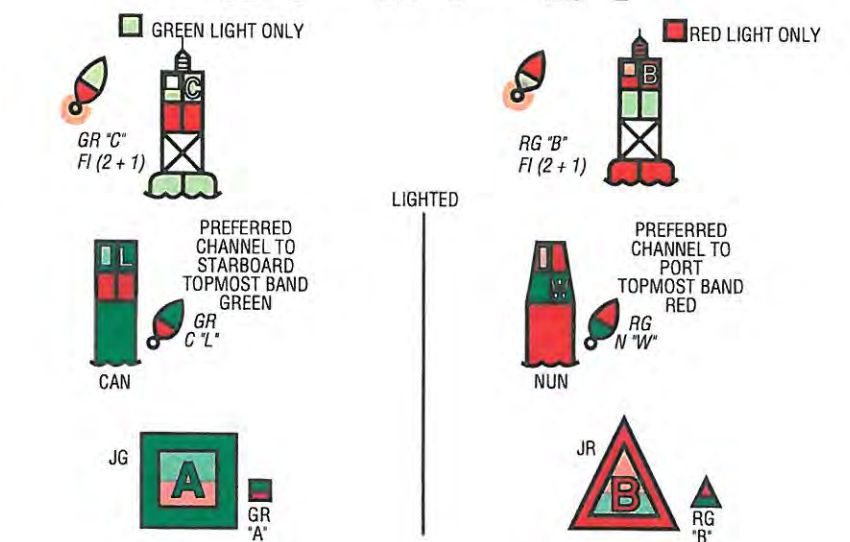
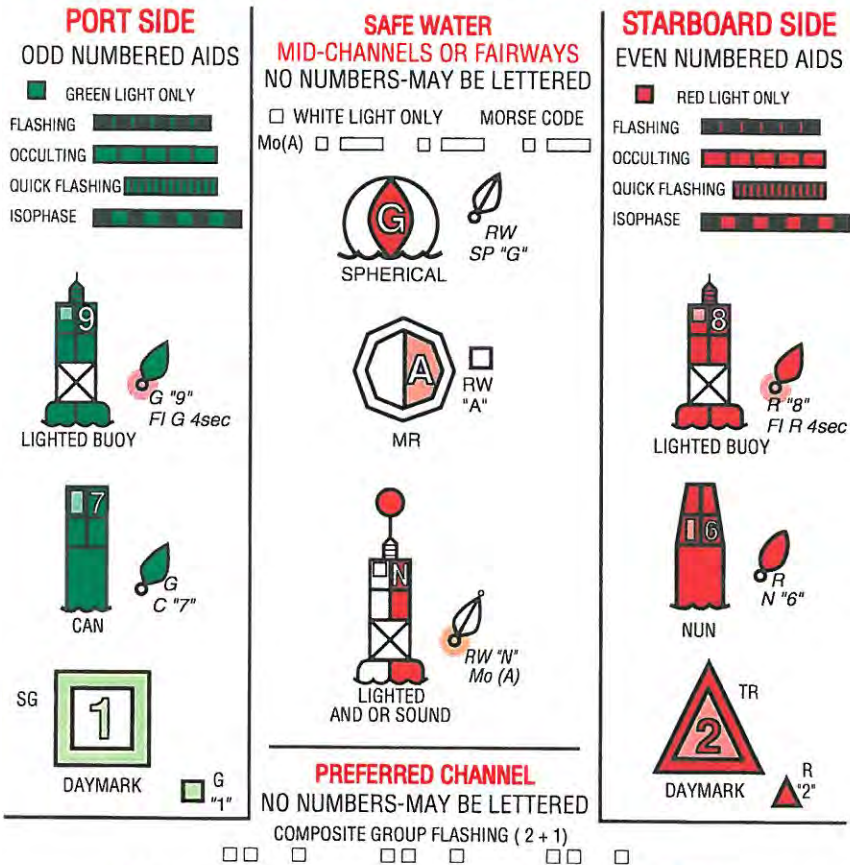

BOATING SAFETY

Your Pontoon owner's manual uses five levels of advisory and hazard statements to alert you to special information, operating procedures or safety precautions. All statements begin with a signal word to identify the importance of the statement. Statement levels follow this order (increasing importance):

Advisory Statements

Advisory statements forewarn conditions that effect equipment operation, maintenance and servicing practices and occur in two levels:

Level 1 - NOTE

Signals a general advisory statement that clarifies or highlights a particular section of text.

Level 2 - IMPORTANT

Used to signal the possibility of damage to equipment or associated components.

Hazard Statements

The use of hazard statements is determined by the likely consequence of the warning with regard to severity (minor injury, severe injury, death), and the probability of severity (COULD result in, WILL result in). Not following the recommendations contained in any of these statements may result in personal injury.

Level 3 - Caution



CAUTION: Hazards or unsafe practices that COULD result in minor personal injury.

Level 4 - Warning



WARNING: Hazards or unsafe practices that COULD result in severe personal injury or death.

Level 5 - Danger



DANGER: Immediate hazards that WILL result in severe personal injury or death.

Recommendations

Boating safety and the safety of your passengers is YOUR responsibility. You should fully understand and become familiar with the following safety precautions before launching your pontoon.

1. Never operate a pontoon while under the influence of drugs or alcohol. Doing so is a Federal offense. Make sure only qualified drivers operate your pontoon.
2. Your pontoon and equipment should be kept in safe operating condition. Regularly inspect the hull, engine, safety equipment and all other boating gear.
3. Extreme **CAUTION** must be utilized while fueling your pontoon. Become familiar with your pontoon's fuel tank capacity and fuel consumption for often used RPMs. Avoid fueling your pontoon at night except under good lighting conditions. Gas spills are hard to see in the dark.
4. Maintain sufficient fuel on board for planned cruising requirements. Keep an adequate reserve of fuel in case your plans change due to adverse weather or

other situations. We recommend planning for about 1/3 of your fuel to be used to reach your destination, 1/3 for your return, and 1/3 to be held in reserve.

5. All regulation lifesaving and fire extinguishing equipment on board, must be eye-catching, unrestricted and in safe operating condition. All passengers should become familiar with the operation and location of all equipment.
6. Keep an eye on the weather. Be aware of possible changing conditions by monitoring local weather broadcasts prior to departure. Strong winds and electrical storms should be personally monitored.
7. Accurate up to date charts of your boating area should always be on board.
8. Before departure file your Cruise Log with a responsible person ashore.
9. Always operate your pontoon with consideration, courtesy and common sense.
10. At least one other passenger aboard should be indoctrinated on the basic operating procedures for handling your pontoon, in the event you unexpectedly become unable to do so.
11. Never allow passengers to ride on areas of your pontoon other than designated seating areas.
12. All passengers should remain seated while the pontoon is moving.
13. Never use the swim platform or boarding ladder while the engine is running. Be aware of the location of the drive units or propellers before entering the water from the swim platform ladder.

14. Study and obey the Rules of the Road. Always maintain complete control of your pontoon.

15. Never overload or improperly load your pontoon.

NOTE: The presence of the pontoon's weight capacity plate does not override your responsibility to use common sense or rational judgment. The capacity of your pontoon is reduced by turbulent water and other adverse weather conditions. You should have prior knowledge of existing water and weather conditions before getting underway.

Water Sports

Water skiing, kneeboarding or riding a towed inflatable apparatus are some of the more popular water sports. Taking part in any water sport requires increased safety awareness by the participant and the pontoon operator. Safety awareness is of primary importance in preventing accidents and injury.



WARNING: Crestliner pontoons are not designed and should not be used for the pulling of para-sails, kites, gliders, or any other device that is designed to become airborne when drawn behind a pontoon.

Everyone participating in a water sport should observe these guidelines:

1. Allow only capable swimmers to take part in any water sport.
2. Always wear a personal flotation device (PFD) approved by the U.S. Coast Guard. Wearing a properly designed PFD will help a stunned or unconscious person stay afloat.

3. Always participate in water sports in safe areas. Stay away from boats, pontoons, beaches, swimmers and heavily traveled waterways.
4. Have a second person aboard to observe what is going on behind the pontoon and keep the driver informed. The driver must give full attention to operating the pontoon and the waters ahead.
5. Give immediate attention to a person who has fallen. He or she is vulnerable in the water alone and may not be seen by other boaters.
6. Approach a person in the water from the lee side (opposite the direction of the wind). Stop the pontoon's motor before coming close to the person.

Figure 1.1 identifies a set of hand signals recommended by the American Water Ski Association (AWSA). Skier, observer and pontoon operator should all know and understand these seven (7) simple signals from the skier.

For more information about water skiing, please contact the American Water Ski Association, 799 Overlook Drive, Winter Haven, Florida 33884 (1-800-533-2972).

Drugs and Alcohol

In the best interest of safety, you **SHOULD** refrain from the use of Drugs and/or Alcohol while operating your boat. Operation of motorized vessels while under the influence is a Federal offense carrying a significant penalty. The use of Drugs and/or Alcohol will decrease reaction time, impede judgement, impair vision, and inhibit your ability to safely operate a pontoon.

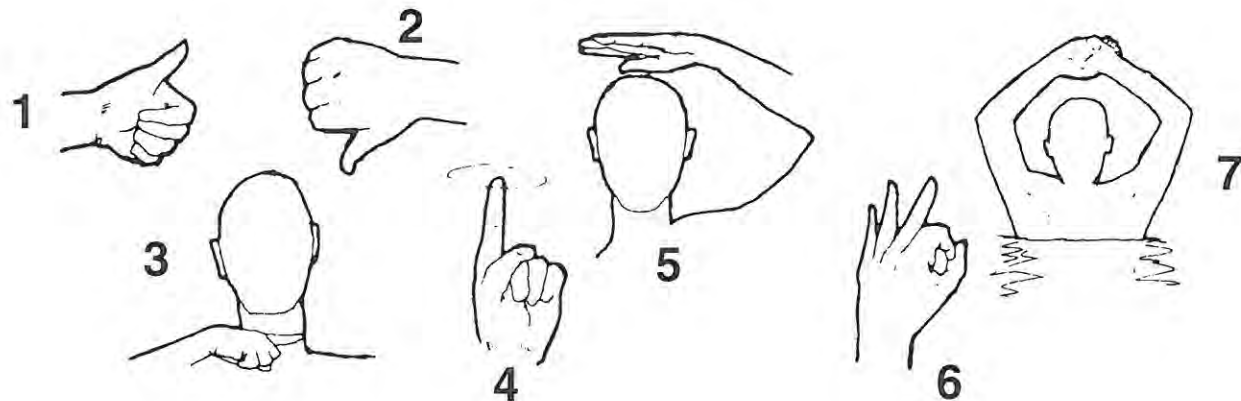

1. **Thumb Up:** Speed up the pontoon.
2. **Thumb Down:** Slow down the pontoon.
3. **Cut Motor/Stop:** Immediately stop pontoon. Slashing motion over neck (also used by driver or observer).
4. **Turn:** Turn the pontoon (also used by driver). Circle motion—arms overhead. Then point in desired direction.
5. **Return to Dock:** Pat on the head.
6. **OK:** Speed and boat path OK. Or, signals understood.
7. **I'm OK:** Skier OK after falling.

FIGURE 1.1 – AWSA WATER SKIING HAND SIGNALS

Safe Boating Courses

Your local U.S. Coast Guard Auxiliary and the U.S. Power Squadrons offer comprehensive safe boating classes several times a year. You may contact the Boat/U.S. Foundation at 1-800-336-BOAT (2628), or in Virginia 1-800-245-BOAT (2628) for a course schedule in your area. Also contact your local U.S. Coast Guard Auxiliary or Power Squadron Flotilla for the time and place of their next scheduled class.

Rules of the Road

Your pontoon is subject to U.S. Coast Guard-enforced marine traffic laws known as “**Rules of the Road.**” There are two sets of rules — the United States Inland Navigational Rules and the International Rules. The United States Inland Rules are applicable to all vessels inside the demarcation lines separating inland and international waters. The “**Rules of the Road**” can be obtained from your local U.S. Coast Guard Unit or the United States Coast Guard Headquarters (1300 E. Street NW, Washington, D.C. 20226) in the publication titled, “**Navigational Rules, International-Inland.**”

“**Aids to Navigation**” (U.S. Coast Guard pamphlet #123) explains the significance of various lights and buoys. This and other pamphlets, including the “**Boating Safety Training Manual,**” and “**Federal Requirements For Recreational Boats**” are also available from the U.S. Coast Guard Headquarters.

Because of proposed alterations in buoys and markers, contact the U.S. Coast Guard to stay informed of impending changes. If you have a ship-to-shore radio telephone on board, heed storm warnings and answer any distress calls.

The spoken word “MAYDAY” is the international signal of distress. “**MAYDAY**” **should NEVER be used unless there is present danger, an emergency, and you are in need of immediate assistance.**

SAFETY UNDERWAY

General Rules of Seamanship

1. Cross waves at right angles.
2. When caught in heavy weather or squalls, head your pontoon either directly into the waves or at a slight angle. Reduce your speed, but maintain enough power to maneuver your pontoon safely.
3. Keep your speed under control. Respect the rights of vessels engaged in fishing, swimming, water skiing, or diving. Give them a “wide berth”.
4. When meeting a vessel head-on, keep to the right whenever possible.
5. When two vessels cross, the vessel to the right or starboard has the right of way.
6. When overtaking or passing, the vessel being passed has the right of way.

Carbon Monoxide and Boating

Carbon monoxide (CO) is a colorless, odorless gas by-product of the burning of carbon based fuels like gasoline. In high concentrations, CO can be fatal within minutes. The effects of CO in lower concentrations are cumulative and can be just as lethal over long periods of time. Symptoms of carbon monoxide poisoning include: itchy and watering eyes, flushed appearance, throbbing temples, inability to think coherently, ringing in the ears, tightness across the chest, headaches, drowsiness, nausea, dizziness, fatigue, vomiting, collapse and convulsions. **CARBON MONOXIDE POISONING IS OFTENTIMES CONFUSED WITH SEA-SICKNESS.**

Outboard motors and stern drive engines exhaust carbon monoxide and other gases typically through the hub or the propeller. To avoid exposure to carbon monoxide, do not stand or swim near the motor when the engine is idling.

Outboard and stern drive powered open boats present a lower risk of exposure to dangerous levels of carbon monoxide from their own motors because natural ventilation dissipates the majority of the engine exhaust. However, engine or generator exhaust from other vessels docked or anchored nearby can emit poisonous carbon monoxide gas and endanger people in the vicinity. Be alert for exhaust from other vessels alongside your pontoon, and monitor people around you for symptoms of carbon monoxide poisoning. If you suspect carbon monoxide poisoning, evacuate the area and move the victim to fresh air. Get medical help immediately.

Carbon monoxide poisoning requires the operator's special and immediate attention! To prevent excess exposure and reduce the possibility of carbon monoxide accumulation in the cockpit, open doors, windows, and canvas enclosures to ensure adequate ventilation.

The following illustrations and text describe some possible situations where carbon monoxide may accumulate within your pontoon while docked, anchored or underway. Become familiar with these examples and their precautions to prevent DANGEROUS accidents.

Exhaust Gas Can Accumulate at Swim Platform

Do not sit on, occupy or hang on any stern appendages (e.g., swim platforms, boarding ladders, etc.) while underway. Do not tow persons in close proximity to the stern of the boat.

⚠ WARNING

WARNING: Engine exhaust outlets near a pier, dock, sea-wall bulkhead or outlets blocked by any other means can cause excessive accumulation of poisonous carbon monoxide gas within the cabin areas. Make sure engine exhaust outlets are not blocked.

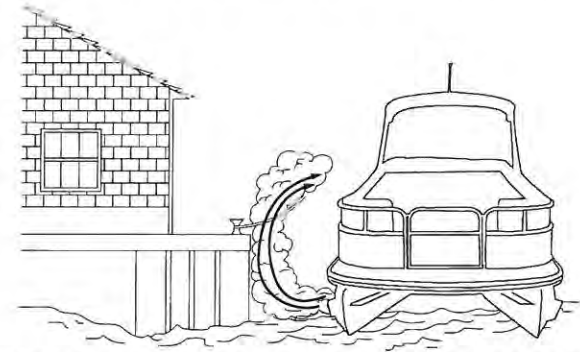

FIGURE 1.2 RUNNING ENGINE IN CONFINED AREAS

⚠ WARNING

WARNING: Generator or engine exhaust from other vessels alongside your pontoon while either docked or anchored can emit poisonous carbon monoxide gas and cause excessive accumulation within the cockpit area of your pontoon. **Be alert for generator exhaust from other vessels alongside your pontoon.**

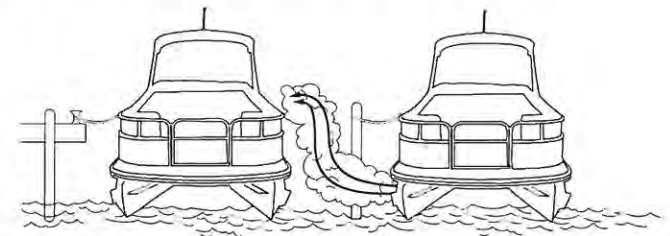

FIGURE 1.3 EXHAUST FUMES FROM VESSEL ALONGSIDE

⚠ WARNING

WARNING: Engine exhaust from your pontoon while underway can cause excessive accumulation of poisonous carbon monoxide gas within the cockpit areas of your pontoon when using protective weather coverings. **Provide adequate ventilation when the canvas top, side curtains and/or back curtains are in their closed protective positions.**

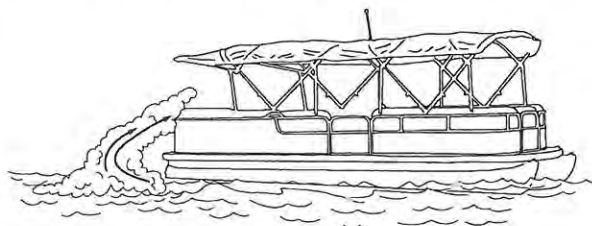

FIGURE 1.4 EXHAUST ACCUMULATION WHILE CANVAS IS IN PLACE

⚠ WARNING

WARNING: Engine exhaust from your pontoon while underway can cause excessive accumulation of poisonous carbon monoxide gas within the cockpit areas of your pontoon when operating pontoon with a high bow angle. **Provide adequate ventilation, redistribute the load or bring pontoon out of high bow angle.**

⚠ WARNING

WARNING: Engine exhaust from your pontoon, when operating at slow speed or stopped in the water, can cause excessive accumulation of carbon monoxide within the cockpit areas. Tail wind can increase accumulation (force of wind entering from aft section of pontoon). **Provide adequate ventilation or slightly increase speed if possible.**

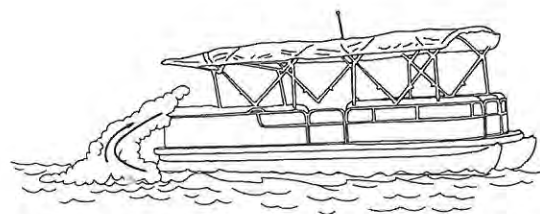

FIGURE 1.5 EXHAUST ACCUMULATION DUE TO HIGH BOW ANGLE OR SLOW SPEED

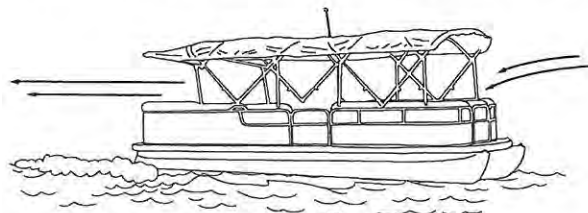

FIGURE 1.6 DESIRED VENTILATION THROUGH THE PONTOON

Navigational Aids Chart

The illustrated Navigational Aids Chart contains information concerning whistle signals, storm warnings, bridge signals and buoy description and information.

Running Aground

If your pontoon runs aground, first check persons aboard for injury. Then check for any damage to the pontoon or propeller(s). Watch the temperature gauge to make sure you do not overheat the engine while running in the shallow water. If the pontoon is not taking on any water, it may be possible to heel the pontoon by shifting the weight of passengers and/or gear and raising the stern drive while reversing the engine.

⚠ WARNING

WARNING: Do not use deck hardware for towing. Crestliner recommends that you use a commercial towing service if your pontoon becomes grounded.

Collision

If a serious collision occurs you should first check the condition of all passengers aboard, then inspect your pontoon to determine the extent of damage.

1. If your pontoon has a ship-to-shore radio, contact (VHF Channel 16) the U.S. Coast Guard or other rescue authorities immediately.
2. Prepare to assist the other craft unless your passengers and/or pontoon are in danger.
3. If the bow of the other vessel penetrated your pontoon's tube, prepare to block the opening once the pontoons are separated.
4. Shore up the hole with a spare PFD or bunk cushion from your pontoon.
5. While blocking the hole, trim weight of the pontoon (where hole exists) so that it is out of the water, if possible.
6. If the extent of damage places your pontoon in a possible sinking condition have all persons aboard put on their PFD (personal flotation devices).
7. Check outdrive lower unit or outboard propeller immediately when pontoon strikes bottom. Operation of pontoon with damaged propeller or lower unit may cause severe damage to engine.

Fire

A fire on board your pontoon is a serious emergency, you must work quickly to implement safety procedures. If a fire occurs, immediately stop the engine.

1. Prompt all persons aboard to put on their PFD (personal flotation device).
2. If the fire is small, attempt to put it out with your fire extinguisher. If the fire is in the engine compartment, turn off the bilge blower. **Do not** open the engine compartment. This feeds oxygen to the fire and flashback could occur.
3. If the fire gets out of control, execute a distress signal, and call for help if equipped with a ship-to-shore radio.
4. All persons aboard should jump overboard and swim a safe distance away from the flames.

IMPORTANT: All persons aboard should know the location and proper operation of the fire extinguishers.

WEATHER

Storms rarely appear without considerable advance notice. Accurate weather information from meteorological observation and reporting stations is available. Weather bureaus are known to have failures in their predictions or information gathering equipment. There is no substitute for a strong understanding of what action to take when the weather takes a turn for the worst. Many marinas fly weather signals. You should learn to recognize these signals, and monitor your local weather forecasts before leaving port.

Storms

The present and forecasted weather conditions are of primary consideration, but a threat of possible storms should always be a concern. Observance of the following information will help in your safety afloat if storms do occur:

- Keep a watch on the horizon for approaching storm indicators.

- Turn radio ON, if available. Dial in local weather station and monitor forecast.
- The best possible situation is to return to a safe port if time allows.
- Stow all loose gear and tie-down any gear required to remain on deck.
- Reduce speed as the seas build. Prompt all persons aboard to put on their PFD (personal flotation devices).
- Place a sea anchor out over the bow to maintain the pontoon's bow into the seas. If there is no sea anchor on board use a canvas bucket or any object that will offer resistance against the flow of the current.
- Radar reflectors (if installed on your pontoon) should be 18 inches diagonally and placed 12 feet above waterline.

Fog

Fog is a result of either warm-surface or cold-surface conditions. You can judge the likelihood of fog formation by periodically measuring the air temperature and dew point temperature. If the spread (difference) between these two temperatures is small you likely will incur a fog situation. Remember the following guidelines:

- As fog sets in take bearings and mark your position on the chart while continuing to log your course and speed.
- Prompt all persons aboard to put on their PFD (personal flotation device).
- If equipped with sounding equipment, you should take soundings and match them with soundings on your charts.
- Station a person forward on the pontoon as a lookout.

- Reduce your speed. From time to time stop engine and listen for other fog signals.
- Sound the horn or fog bell intermittently to warn other boaters.
- If there is any doubt in continuing boat movement, anchor. Listen for other fog signals while continuing to sound the fog horn or bell.

SAFETY EQUIPMENT

NOTE: As the owner of the pontoon, you are responsible for supplying a fire extinguisher approved by the U.S. Coast Guard and all other required safety equipment. Check state and local regulations and call the U.S. Coast Guard Boating Safety Hotline at 1-800-368-5647 for information about required safety equipment. You should also consider supplying additional equipment recommended for your safety and that of your passengers. Make yourself aware of its availability and its use.

Personal Flotation Devices (PFDs)

United States Coast Guard (USCG) approved wearable personal flotation devices of Type I, II, III or IV must be on board your pontoon. The PFDs must be of a suitable size for each person aboard and shall be in serviceable condition and readily accessible.

PFD TYPE I, WEARABLE

This PFD has the greatest required buoyancy. Its design allows for turning most unconscious persons in the water from face down position to a vertical or slightly backward position. Type I is most effective for all waters, especially offshore when rescue may be delayed.

PFD TYPE II, WEARABLE

Type II turns its wearer the same as Type I, but the turning action is not as pronounced as the Type I. The Type II will not turn as many persons under the same conditions as a Type I.

PFD TYPE III, WEARABLE

Type III allows the wearers to place themselves in a vertical or slightly backward position. Type III has the same buoyancy as a Type II PFD. It has little or no turning ability.

PFD TYPE IV, THROWABLE (REQUIRED IN ADDITION TO THE ABOVE MENTIONED PFDs)

The PFD Type IV can be thrown to a person in the water, grasped and held by the user until rescued. The design does not allow for it to be worn. The most common Type IV PFDs are a buoyant cushion or ring buoy. The throwable Type IV PFD shall be immediately available for use and in serviceable condition.

PFD TYPE V WEARABLE

This PFD must be worn to be effective. When inflated, it provides buoyancy equivalent to Type I, II or III PFDs. When it is deflated, however, it may not support some people.

Fire Extinguishers

All Class 1 (16 to 26 feet) powerboats are required to carry one (1) B-I type hand portable fire extinguisher, if not equipped with a fixed (Halon) fire extinguishing system in the engine compartment.

All hand portable fire extinguishers should be mounted in a readily accessible location, and away from the engine compartment. All persons aboard should know the location and proper operation of the fire extinguisher(s).

If your fire extinguisher has a charge indicator gauge, cold or hot weather may have an effect on the gauge reading. Consult the instruction manual supplied with the fire extinguisher to determine the accuracy of the gauge.

Visual Distress Signal Devices

Visual Distress Signal devices are required and may be of the pyrotechnic or non-pyrotechnic type. The regulation requires all recreational boats when used on coastal waters, which includes the Great Lakes, territorial seas and those waters directly connected to the Great Lakes and the territorial seas, up to a point where the waters are less than two miles wide, and the boats owned in the United States when operating on the high seas, to be equipped with visual distress signal devices.

Pyrotechnic and non-pyrotechnic equipment must be U.S. Coast Guard approved, in serviceable condition and stowed in a readily accessible location. Equipment providing a date for serviceable life, must be within the specified usage date as shown.

PYROTECHNIC EQUIPMENT

Pyrotechnic U.S. Coast Guard approved visual distress signals and associated equipment include:

- Red flares, hand held or aerial
- Orange smoke, hand held or floating
- Launchers for aerial red meteors or parachute flares

NON-PYROTECHNIC EQUIPMENT

- Orange distress flag
- Electric distress light

No single signaling device is flawless under all conditions for all purposes. Consideration should be given to possessing various types of equipment. Careful selection and

proper stowage of the equipment is very **IMPORTANT** if young children are frequently aboard.

Sound Signaling Device

All Class 1 (16 to 26 feet) powerboats are required to carry a hand, mouth or power operated horn or whistle. It must produce a blast of two-second duration and audible at a distance of at least one-half (1/2) mile.

Navigation Lights

Pontoons operating between sunset and sunrise are required to display appropriate navigation lights.

ADDITIONAL RECOMMENDED EQUIPMENT

The following list (not an exhaustive list) indicates some additional recommended equipment which should be considered for safe enjoyable boating.

Tools

- Spark plug wrench
- Screw drivers
- Pliers
- Adjustable wrench
- Hammer
- Jackknife
- Electrician's tape
- Lubricating oil

Spare Parts

- Extra Bulbs
- Extra fuses
- Extra drain plug
- Shearpin (if used)
- Spare Propeller
- Extra prop nut and washer
- Spark plugs
- Spare wire

Basic Gear

- Anchor and Line
- Tow line
- Mooring lines
- Flashlight
- Oar or paddle
- Compass

- Dock Fenders
- First aid kit
- Foul weather gear
- VHF radio
- Searchlight
- Ring buoy
- Distress signals
- Pontoon hook
- Charts or navigation maps
- Signal mirror
- Sunburn lotion
- Binoculars

BOATING LAWS & REGULATIONS

Pontoon Registration

Federal and state laws require that every pontoon equipped with propulsion machinery of any type must be registered in the main state of usage. Registration numbers and validation stickers must be displayed on the pontoon according to regulations. The registration certificate must be carried on board when the pontoon is in use.

Discharge of Oil

The Federal Water Pollution Control Act prohibits the discharge of oil or oily waste into or upon the navigable waters of the United States or the waters of the contiguous zone if such discharge causes a film or sheen upon or a discoloration of the surface of the water or causes a sludge or emulsion beneath the surface of the water. Violators are subject to a penalty of \$5,000.

Disposal of Plastics & Other Garbage

Plastic refuse dumped in the water can kill fish and marine wildlife, and can foul vessel propellers and cooling water intakes. Other forms of waterborne garbage can litter our beaches and make people sick. U.S. Coast Guard regulations completely prohibit the dumping of plastic refuse or other garbage mixed with plastic into the water anywhere, and restrict the dumping of other forms of garbage within specified distances from shore.

ILLEGAL TO DUMP

INSIDE 3 MILES

(and in U.S. Lakes, Rivers, Bays and Sounds)

- **PLASTIC**
- **DUNNAGE, LINING AND PACKING MATERIALS THAT FLOAT**
- **ANY GARBAGE EXCEPT DISHWATER/GRAYWATER/FRESH FISH PARTS**

3 TO 12 MILES

- **PLASTIC**
- **DUNNAGE, LINING AND PACKING MATERIALS THAT FLOAT**
- **ANY GARBAGE NOT GROUND TO LESS THAN ONE SQUARE INCH**

12 TO 25 MILES

- **PLASTIC**
- **DUNNAGE, LINING AND PACKING MATERIALS THAT FLOAT**

OUTSIDE 25 MILES

- **PLASTIC**

The U.S. Coast Guard has issued these regulations to implement Annex V of the International Convention for the Prevention of Pollution from Ships, 1973, commonly known as Annex V of the MARPOL (Marine Pollution) Treaty 73/78. They apply to all U.S. vessels wherever they operate (except waters under the exclusive jurisdiction of a State), and foreign vessels operating in U.S. waters out to and including the Exclusive Economic Zone (200 miles).

IMPORTANT: It is illegal to discharge waste from your marine sanitary device into the water in most areas. It is your responsibility to be aware of and adhere to all local laws concerning waste discharge. Consult with the coast guard, local marina, or your Crestliner dealer for additional information.

Table of Contents

LINE DRAWINGS	i	PRE-LAUNCH & UNDERWAY (CONT.)	3
WELCOME ABOARD	1	Getting Underway	3.10
Owner's Manual Structure.....	1.1	Controls.....	3.11
Responsibilities	1.2	Starting Procedures	3.12
Pontoon Records	1.3	Trimming	3.14
Warranty.....	1.3	Additional Underway Information	3.15
Crestliner Pontoon Log (Form).....	1.4	Engine Shut Down	3.16
Crestliner Cruise Log (Form)	1.5	Reloading Your Pontoon.....	3.16
Crestliner Fuel Usage Log (Form).....	1.6	MAINTENANCE	4
Navigational Aids Chart	1.8	Service & Maintenance Schedule	4.1
Boating Safety	1.9	CARE & APPEARANCE	5
Safety Underway	1.12	Tube and Fence Care.....	5.1
Weather	1.15	Upholstery.....	5.2
Safety Equipment.....	1.16	Windshields and Windows	5.2
Additional Recommended Equipment.....	1.18	Carpeting	5.3
Boating Laws & Regulations	1.18	Canvas	5.3
Illegal to Dump	1.19	WINTERIZATION & STORAGE	6
SYSTEMS & COMPONENTS	2	Prior to Storage.....	6.1
Safety Labels	2.1 - 2.2	Engine.....	6.1
Systems	2.3	Livewell	6.2
Equipment.....	2.5	Interior Cleaning.....	6.2
Livewell	2.8	If You Store Your Pontoon on a Trailer	6.3
Seating.....	2.9	Recommissioning.....	6.3
Troubleshooting.....	2.10	PONTOON TERMINOLOGY	7
PRE-LAUNCH & UNDERWAY	3		
Trailerling	3.1		
Launching	3.2		
Loading	3.4		
Anchoring.....	3.6		
Fueling Recommendations	3.6		

This section introduces information related to major systems and components that are or can be installed on your Crestliner Pontoon Boat.

Your pontoon may not have all the equipment and/or controls described in this manual as equipment levels vary by model. Consult your dealer when in doubt as to how information in this manual pertains to your pontoon.

You will see equipment safety labels at various locations on your pontoon. Crestliner has displayed these labels to help ensure that the time you spend on your pontoon is safe and enjoyable. Please do your part by reading ALL safety labels. Understanding the information on these labels is of vital importance. Check with your dealer if you have any questions about the labels or if they are missing from your pontoon. These safety labels should be on your pon-

toon:

⚠ CAUTION

Rear Center Lid must be in elevated position to allow for motor tilt.

DO NOT TRANSPORT WITH TOP IN OPEN POSITION

NOTICE: TROLLING MOTOR MUST BE REMOVED TO INSTALL CANVAS

⚠ WARNING



Avoid serious injury or death from fire or explosion, resulting from leaking fuel. Inspect system for leaks at least once a year.

The use of fuels containing ethanol higher than 10% (E-10) can damage your engine or fuel system and will void the warranty. Never use (E-85).

⚠ WARNING



Fuel vapors are a fire and explosion hazard. To avoid injury or death, do not store fuel or flammable liquids here.

GM1850701

⚠ WARNING

AVOID INJURY OR DEATH FROM CONTACT WITH PROPELLER OR GEAR CASE DUE TO FALLING OVER THE BOW

WHEN ENGINE IS RUNNING (IN ANY GEAR, FORWARD-NEUTRAL-REVERSE) DO NOT SIT ON OR HANG LEGS OVER THE FORWARD END OF THE DECK.

STAY INSIDE THE FENCES AND SEATED IN AN APPROPRIATE SEAT. KEEP ALL GATES CLOSED AND LATCHED.

⚠ WARNING



Carbon monoxide (CO) can cause brain damage or death.

Engine and generator exhaust contains odorless and colorless carbon monoxide gas.

Signs of carbon monoxide poisoning include nausea, headache, dizziness, drowsiness, and lack of consciousness.

Get fresh air if anyone shows signs of carbon monoxide poisoning.

See Owner's Manual for information regarding carbon monoxide poisoning.

⚠ DANGER



Carbon monoxide (CO) can cause brain damage or death.

Engine and generator exhaust contains odorless and colorless carbon monoxide gas.

Carbon monoxide will be around the back of the boat when engines or generators are running.

Move to fresh air if you feel nausea, headache, dizziness or drowsiness.

SAFETY LABELS

 **WARNING**



Do not use ski tow fitting for lifting or parasailing. Fitting could pull out of deck resulting in serious injury or death.

GM1850801

 **WARNING**



Rotating propeller can cause serious injury or death. Shut off motor when near persons in water.

GM1850901

 **WARNING**



Rotating propeller can cause serious injury or death. Never approach or use ladder when motor is running.

GM1851001

 **WARNING**



Prevent falls overboard. Close, latch and stay inside gate(s) while underway.

GM1851101

BOATMAN'S CHECK LIST

For maximum enjoyment and safety, check each of these items BEFORE you start your engine:

- DRAIN PLUG (Securely in place?)
- LIFE-SAVING DEVICES (One for every person on board?)
- STEERING SYSTEM (Working smoothly and properly?)
- FUEL SYSTEM (Adequate fuel? Leaks? Fumes?)
- BATTERY (Fully charged? Cable terminals clean and tight?)
- ENGINE (In neutral?)
- CAPACITY PLATE (Are you overloaded or overpowered?)
- WEATHER CONDITIONS (Safe to go out?)
- ELECTRICAL EQUIPMENT (Lights, horn, pump, etc.?)
- EMERGENCY GEAR (Fire extinguisher, bailer, paddle, anchor & line, signalling device, tool kit, etc.?)

 **WARNING**

A wide variety of components used on this vessel contain or emit chemicals known to the State of California to cause cancer and birth defects and other reproductive harm.

EXAMPLES INCLUDE:

- Engine and generator exhaust
- Engine and generator fuel, and other liquids such as coolants and oil, especially used motor oil
- Cooking oils
- Cleaners, paints, and substances used for vessel repair
- Waste materials that result from wear of vessel components
- Lead from battery terminals and from other sources such as ballast or fishing sinkers

TO AVOID HARM:

- Keep away from engine, generator, and cooking fuel exhaust fumes
- Wash areas thoroughly with soap and water after handling the substances above

SAFETY LABELS

SYSTEMS

⚠ CAUTION

CAUTION: READ ALL literature materials supplied with your pontoon prior to operating any of the systems and components. Any electrical accessories you would like to add to your pontoon should be installed by your dealer or a qualified electrician. Improper installation could result in damage to your boat's electrical system and/or cause a fire.

IMPORTANT: Operation, maintenance, and safety information is outlined by the manufacturer of most installed equipment. Properly operating and maintaining the equipment on your pontoon will help you to enjoy many years of **SAFE** boating.

12-Volt DC Electrical System

Your pontoon's 12-Volt DC system obtains its power from a battery. The battery is charged through the engine-driven alternator and/or an AC battery charger. The voltmeter on the helm dash instrument panel indicates the charging level of the battery. Depending on which Crestliner model you own, there could be fuses on either the distribution panel or instrument panel, that control the operation of DC equipment on your pontoon.

The negative terminal of the battery is connected to the grounding studs of the main engine. This type of negative ground system is the approved system for marine DC electrical systems. If additional equipment is to be installed, it must be adaptable to the negative ground system. When installing additional equipment, ensure that each item's current supply is taken from the main DC distribution panel. All required additional circuit protection must also be added at the DC distribution panel.

NOTE: Power feeds for accessory equipment must NOT be taken from the voltmeter terminals.

⚠ WARNING

WARNING: Do not use E85 fuel in this product. Do not use fuel or additives containing more than 10% alcohol by volume (methanol or ethanol).

Fuel System (Figure 2.1)

The internal fuel system on board your pontoon is designed to meet or exceed federal requirements, at the time of manufacture, of the U.S. Coast Guard.

The fuel system has been factory inspected and pressure tested in accordance with regulations in effect at time of manufacture. Additionally, each fuel tank must pass rigid tests and inspections performed by the fuel tank manufacturer.

Before you take delivery of your pontoon, check that your dealer completes a full inspection of the entire fuel system. You should also inspect the entire system at least once a year.

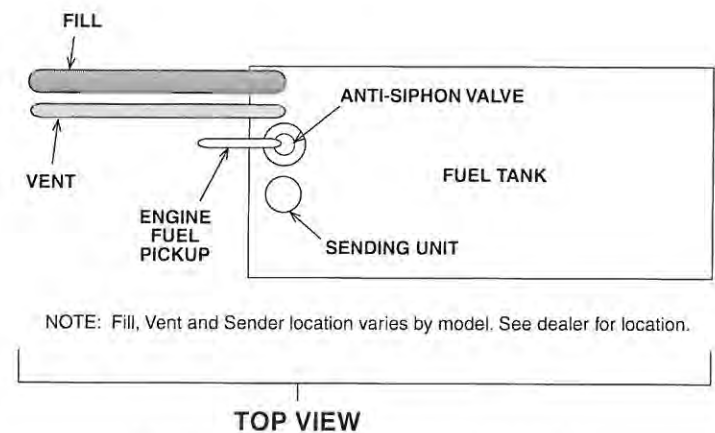
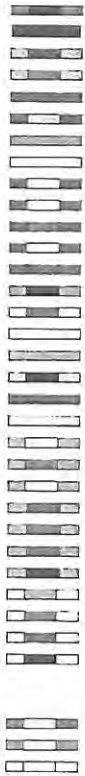

FIGURE 2.1 - FUEL SYSTEM



Crestliner Wiring Color Code & Chart



Pontoon Function – All Models			
Wire	Location	To	Location
Red/Black	Transom Circuit Protection	to	Dash Circuit Protection
Black	Battery Negative	to	All Ground Circuits
Gray/Blue	Navigation Switch	to	Stem Light
Gray/Green	Navigation Switch	to	Bow Light
Dk. Brown	Bilge Pump Switch (Manual)	to	Manual Bilge Pump
Dk. Brown/Orange	Livewell Switch 1/Pump	to	Livewell Pump 1/Right
Pink	Main or Starboard Gas Sender	to	Gas Gauge
Yellow	Blower Switch	to	Blower
Dk. Blue/Yellow	Interior Lights Switch	to	Interior Lights
Dk. Blue/White	Interior Lights Circuit Protector	to	Interior Lights
Dk. Brown/Red	Bilge Pump Circuit Protector	to	Au. To Bilge Pump Float
Dk. Brown/Yellow	Livewell Switch/Recirculation	to	Recirculation/Sink Pump
Dk. Brown/Blue	Livewell Switch 2/Pump	to	Livewell Pump 2/Left
Pink/Black	Auxiliary or Port Gas Sender	to	Gas Gauge
Purple/Red	Continuous Power Source	to	Radio/Accessory
White	Horn Switch	to	Horn
Orange	Switch Power Source	to	Radio / Accessory
Gray/Black	Docking Light Switch	to	Docking Lights
Dk. Blue	Navigation Switch	to	Dash Lights
Purple	Ignition Switch	to	Dash Gauges Positive
Orange/White	Horn Circuit Protection	to	Horn Switch
Orange/Green	Navigation Circuit Protection	to	Navigation Switch
Orange/Yellow	Blower Circuit Protection	to	Blower Switch
Orange/Dk. Brown	All Pumps Circuit Protection	to	All Pump Switches
Orange/Red	Accessory Circuit Protection	to	Accessory Switches
Orange/Blue	Interior Lights Circuit Protection	to	Interior Light Switches
Orange/Black	Docking Lights Circuit Protection	to	Docking Light Switches
Lt. Brown/Orange	Starboard Wiper Switch Cont. Hot	to	Starboard Wiper Pos. Post
Lt. Brown/Red	Port Wiper Switch Cont. Hot	to	Port Wiper Pos. Post
Lt. Brown/Blue	Port Wiper Switch	to	Port Wiper S. Post
Lt. Brown/Black	Starboard Wiper Switch	to	Starboard Wiper S. Post
Clear 18-2 Copper / Silver	Radio	to	Speaker Positive
	Radio	to	Speaker Ground
Lt. Red/White	Tilt / Trim Switch	to	Engine Mounted Fuse
Lt. Blue/White	Trim Up Solenoid	to	Trim Up Solenoid
Lt. Green/White	Trim Down Solenoid	to	Trim Down Solenoid



Boat Function – Troll Motor			
Red	Troll Motor Battery 1	to	Troll Motor plug 2 Positive (12 volt)
Red	Troll Motor Battery 1	to	Troll Motor plug 3 Positive (24 volt)
Black	Troll Motor Battery 1	to	Troll Motor plug 1 Negative
Red/Blue	Troll Motor Battery 2	to	Troll Motor 2 Positive
Black/Blue	Troll Motor Battery 2	to	Troll Motor 2 Negative



Engine Functions Mercury Outboard			
Black	Battery Negative	to	Ignition Switch / M1 Post
Black/Yellow	Magne Ground	to	Ignition Switch / M2 Post
Red	Engine Mounted Fuse	to	Ignition Switch / B Post
Purple	Alternator Output	to	Ignition Switch / A Post
Yellow/Black	Electric Choke	to	Ignition Switch / C Post

RF-PS 3017.1

- Fuel Fill Plate** – All Pontoon Boats equipped with an internal fuel tank may have a fuel fill plate and are labeled FUEL. Be sure to utilize the proper grade fuel as specified in your engine owner's manual.
- Fuel Vent** – The internal fuel tank is vented overboard. While the tank is being filled, the air is expelled by the fuel and escapes through the fuel vent. When the fuel tank is almost FULL, fuel will be ejected from the fuel vent.
- Anti-Siphon Valve** – Engine fuel pick up lines on pontoon boats are equipped with an anti-siphon valve where the line attaches to the internal fuel tank. The valve prevents gasoline from siphoning out of the fuel tank in the event of a fuel line separation.
- Fuel Filter** – The fuel filter supplied by engine manufacturers is installed on or near the engine. The filter should be replaced frequently to maintain an adequate supply of clean, uncontaminated fuel to the engine.
- Fuel Tank** – The internal fuel tank is accessible through a removable cover board and is equipped with a fuel vent line, fuel fill line, sending unit, and engine fuel pickup as shown in Figure 2.1. Some models with a permanent tank need to be visually inspected. Some models have a portable fuel tank.

Protection Against Electrolysis

IMPORTANT: It is the pontoon owner's responsibility to periodically inspect and replace the sacrificial zinc anodes on the outboard motor and/or stern drive. Damage resulting from electrolytic corrosion is not covered by the Crestliner Warranty.

Sacrificial zinc anodes, installed by the dealer or the engine manufacturer, protect the hardware that is exposed

to the water. Electrolysis attacks the softest or least “noble” metals first. Because zinc is a less “noble” metal, it will decompose before the more “noble” metals. Check these zinc anodes periodically and have them replaced as required. See your Crestliner dealer for parts and service.

Optional Marine Sanitation Device (MSD)

The Marine Sanitation Device (MSD), or head, installed on your boat is a marine head (See Figure 2.2). This portable toilet (porta potti) provides simple operation and convenient disposal of waste. The waste is either transported off the boat by removing the holding tank, or by using the pump-out plate at dockside, if so equipped.

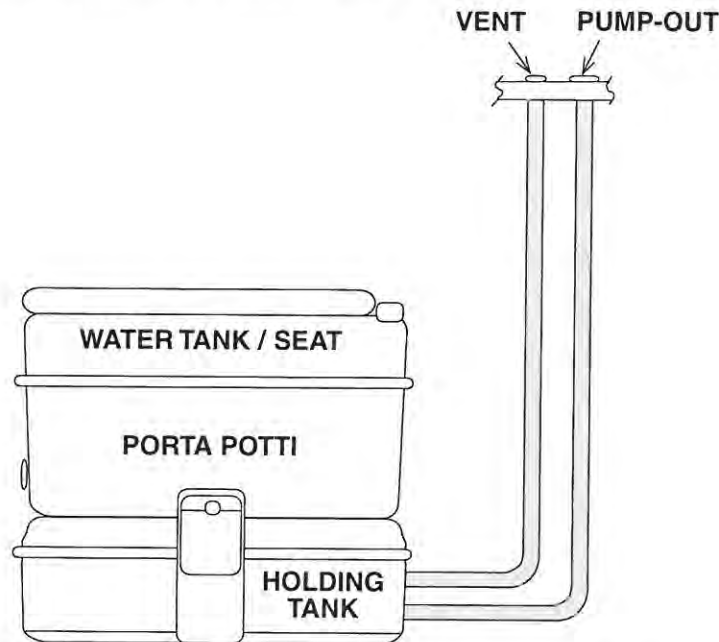

FIGURE 2.2 – ENCLOSED MARINE HEAD WITH PUMP-OUT

IMPORTANT: It is illegal to discharge waste from your marine sanitary device into the water in most areas. It is

your responsibility to be aware of and adhere to all local laws concerning waste discharge. Consult with the Coast Guard, local marina, or your Crestliner dealer for additional information.

Engine Exhaust System (Stern drives only)

The exhaust system collects engine combustion gases and exhausts them through the drive unit. The hydrocarbons in engine exhaust are pollutants. A well-tuned engine operating at its best reduces air and water pollution by exhausting fewer hydrocarbons.

⚠ WARNING

WARNING: Exhaust gases contain carbon monoxide. Carbon monoxide is poisonous and can cause unconsciousness or death. Shut down engine immediately if any exhaust leaks are detected.

Visually inspect the engine exhaust system (hoses, joints, manifolds, etc.) for leaks. Make sure all clamps are tight. Check hoses for damage. Have your dealer replace any damaged exhaust system component.

NOTE: Any discoloration around a joint or gasket usually indicates a leak.

EQUIPMENT

Various pieces of equipment on your pontoon are supplied with manuals specific to that product. The information in these manuals supersedes the information in the Crestliner Owner's manual. Owner's are responsible for reading all manuals supplied with their pontoon.

⚠ WARNING

WARNING: When using electrical components, observe basic safety precautions to reduce the risk of fire, electrical shock, personal injury or damage to your boat and/or component.

Battery

Marine batteries use an absorbent electrolyte principle to provide high reserve capacity, plus cold cranking performance.

Check with your dealer if you wish to install more than one battery on your boat. All batteries should be installed in such a manner that they are electrically isolated from each other.

⚠ WARNING

WARNING: During charging, batteries produce gases which can explode if ignited. Explosion can shatter the battery. Acid can cause severe personal injury such as blindness. Keep flame, spark and smoking materials away from battery while charging. Charge battery in a well-ventilated area.

Batteries produce hydrogen and oxygen gases when being charged. These explosive gases escape through the vent/fill caps and may form an explosive atmosphere around the battery if ventilation is poor. This gas may remain around the battery for several hours after charging. Sparks or flames can ignite the gas and cause an explosion.

⚠ WARNING

WARNING: POISON! Batteries contain sulfuric acid which can cause severe burns. Avoid contact with skin, eyes or clothing. Wear goggles, rubber gloves and protective apron when working with a battery. In case of contact, flush with water at least 15 minutes. If swallowed, drink large quantities of water or milk. Follow with Milk of Magnesia, beaten egg or vegetable oil. Get medical attention immediately.

Battery Charger

Your pontoon may be equipped with a battery charger that can charge the trolling motor battery. It is very important that you read the battery charger manual for the proper safety and operation instructions before using the battery charger.

Lanyard Stop Switch

(This switch does not apply to all motors)



⚠ CAUTION

CAUTION: The lanyard stop switch should not be used as the normal engine shut off.

The purpose of this safety device is to stop the engine when the operator leaves the control station accidentally by falling into the pontoon or by falling or being ejected overboard.

The lock plate on the end of the lanyard must be attached to the engine stop switch for the engine to run. Securely attach the lanyard to the operator's clothing, arm or leg. Be careful not to attach the lanyard to clothing that could easily tear loose or to place it where it can become entangled. Either situation defeats the lanyard's purpose.

Bilge Pump

NOTE: The Federal Water Pollution Act prohibits the discharge of oil or oily waste into or upon the navigable waters and contiguous zone of the United States if such discharge causes a film or sheen upon, or discoloration of, the surface of the water, or causes a sludge or emulsion beneath the surface of the water. Violators are subject to a penalty of \$5000.

The bilge pump is used to remove water from the bilge. Many models are equipped with a manual bilge pump that operates only when you turn on the switch at the helm. The pump stops as soon as you turn the switch off.

Some stern drive models are equipped with an automatic bilge pump. Rising water in the bilge activates a float switch to start the pump. When most of the water has been pumped out, the float switch automatically shuts the pump off. Automatic bilge pumps can also be turned on manually using the switch at the helm.

IMPORTANT: Electrically operated bilge pumps can fail. There is no substitute for checking the bilge frequently, especially during periods of heavy rain, high seas, or storm conditions.

If for some reason the pump fails to start, check the fuse and wiring connections. If the pump motor runs but no water is discharged, it may be clogged. Keep the area around the switch and the pump free of debris. If there is no visible debris clogging the pump or blocking the float switch and water is still not being removed, inspect the discharge hose for kinks or obstruction.

If oil or fuel is spilled in the bilge, do not run the pump. Keep the oil or fuel from spreading in the bilge and properly dispose of it on shore. Your dealer can help you select products you can use to soak up the oil or fuel and give you advice about methods of disposal.



WARNING: Never assume all explosive fumes have been removed from the engine compartment. If you detect any fuel odors, shut down the engine and electrical circuits, and immediately determine the source of the odor.

Navigation Lights

Although activities are limited at night, night cruising can be pleasurable. Be especially careful of shallow waters and be on the watch for submerged debris, rocks, and other obstacles in the water. Navigation lights are intended for collision avoidance only and are not intended to improve the operator's night vision.

If your pontoon has factory installed navigational lights, the all-around light is white, and there is a red and green light for the port and starboard side respectively.

Check lights for proper operation before heading out. You should also learn to identify the running light combinations

for other vessels. We recommend your participation in a boating safety course to further learn about navigation lights and safe boating practices.

The navigation lights are controlled at the helm by a three-position switch. This allows for selection of the all-around (white) light ON when anchored or moored, or to have the all-around (white), port (red) and starboard (green) lights all ON while underway and all lights are OFF in the OFF position.

Marine Stereo (Standard or Optional)

The unit is a highly sensitive electronic tuning AM/FM stereo receiver with CD player. This unit may be adjusted to improve radio reception. Your dealer can help you with this adjustment. Refer to the stereo manual for operating instructions.

LIVEWELL (Standard or Optional)

An aerated livewell is included as standard equipment on some models. The primary function of the livewell is to provide the means for keeping your catch alive until your day of fishing ends. Figure 2.3 shows a typical livewell system.

The livewell system has a pump that draws water in and pumps the water into the livewell.

Water above the level of an overflow, a standpipe or a fitting, on the side of the livewell flows through a hose and out through a fitting on the floor. Removing a drain tube in the bottom of the livewell drains water from the livewell through a fitting in the pontoon floor below the level of the bottom of the livewell.

To fill the livewell:

1. Be sure the tube is in place in the bottom livewell drain.

2. Toggle the LIVEWELL switch at the helm panel to ON. The livewell pump will start, and the livewell will fill with water up to the level of the overflow.
3. Toggle the switch OFF when the livewell is filled.
4. Adjust by turning spray head in or out.

Operate the livewell pump as needed to freshen and maintain the oxygen supply by aerating the water in the livewell.

To ensure that your livewell remains clean and the water in it remains fresh, empty the livewell after you have finished using it. To drain the livewell, remove the drain tube in the bottom. If you are leaving your pontoon in the water, insert the drain tube and bail the remaining water from the livewell.

IMPORTANT: If water in the livewell system freezes, hoses can break as the frozen water expands. Be sure to empty the livewell completely during freezing weather.

Do not operate the livewell pump if it is not pumping water. Operating the pump dry can overheat its water-cooled motor and damage the unit. If water does not come out of the aerator nozzle:

1. Check the livewell fuse on the bow panel. Replace the fuse if necessary.
2. Make sure the pump is not clogged. If the pump is clogged, you may be able to clear the obstruction by forcing water back through the pump. Using a garden hose, direct water flow into the pump outlet until water flows freely from the inlet.
3. Make sure current is reaching the pump. Check and tighten connections. Make sure wires are not broken.

If you still have problems with the pump, contact your dealer.

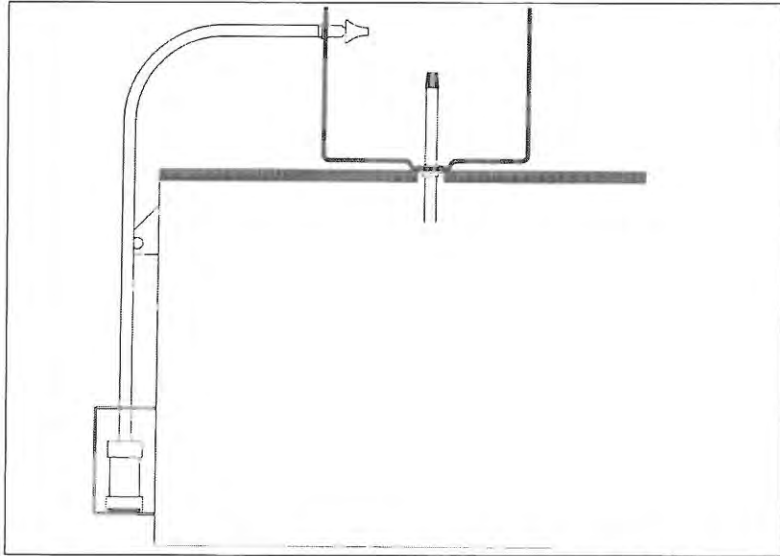

FIGURE 2.3 - MANUAL LIVEWELL

SEATING



Many Crestliner Pontoon are equipped with swivel seats. Most swivel seats have locking mechanisms, which when engaged, will prevent the seat from turning. These seats must be locked in



order to be used when the pontoon's speed exceeds five miles per hour. Swivel seats without a locking mechanism must not be used when the pontoon's speed exceeds five miles per hour.



TROUBLE SHOOTING

DC ELECTRICAL SYSTEM

CAUTION !
ELECTRIC SHOCK! EQUIPMENT DAMAGE! Disconnect battery cables before performing all inspections, checks, and repairs to avoid possible personal injury and damage to equipment.

Problem	Causes	Solution
No power to 12v equipment	Weak or dead battery	Recharge battery
Battery not charging (engine running)	Engine alternator malfunction	See dealer
Battery not holding a charge	Bad battery	Replace battery
12-v device not working	Circuit breaker for device is OFF	Reset breaker to ON
	Fuse is blown	Replace fuse
	Weak or dead battery	Charge battery
	Faulty electrical connection	Check 12-V connections. Tighten or repair as needed
	Device is not connected	Verify all wires are connected

ENGINE		
Problem	Causes	Solution
Engine will not start	Battery dead	Charge battery or replace
	Bad connections	Clean battery connections and make sure all are tight
	Control not in neutral	Shift control to neutral
	Ignition interrupter disconnected	Re-connect Ignition interrupter
	No fuel	Check that tank has fuel, Fill if necessary
	Other engine problems	Check fittings, connections feel lines for blockages repair or clean as required See dealer

NOTE: ALSO REFER TO SECTIONS #2, #3 AND # 4 IN THIS MANUAL FOR SYSTEMS, EQUIPMENT, LIVE WELL, FUEL, CONTROLS, STARTING PROCEDURES AND MAINTENANCE INFORMATION.

Table of Contents

LINE DRAWINGS	i	PRE-LAUNCH & UNDERWAY (CONT.)	3
WELCOME ABOARD	1	Getting Underway	3.10
Owner's Manual Structure	1.1	Controls	3.11
Responsibilities	1.2	Starting Procedures	3.12
Pontoon Records	1.3	Trimming	3.14
Warranty	1.3	Additional Underway Information	3.15
Crestliner Pontoon Log (Form)	1.4	Engine Shut Down	3.16
Crestliner Cruise Log (Form)	1.5	Reloading Your Pontoon	3.16
Crestliner Fuel Usage Log (Form)	1.6	MAINTENANCE	4
Navigational Aids Chart	1.8	Service & Maintenance Schedule	4.1
Boating Safety	1.9	CARE & APPEARANCE	5
Safety Underway	1.12	Tube and Fence Care	5.1
Weather	1.15	Upholstery	5.2
Safety Equipment	1.16	Windshields and Windows	5.2
Additional Recommended Equipment	1.18	Carpeting	5.3
Boating Laws & Regulations	1.18	Canvas	5.3
Illegal to Dump	1.19	WINTERIZATION & STORAGE	6
SYSTEMS & COMPONENTS	2	Prior to Storage	6.1
Safety Labels	2.1 - 2.2	Engine	6.1
Systems	2.3	Livewell	6.2
Equipment	2.5	Interior Cleaning	6.2
Livewell	2.8	If You Store Your Pontoon on a Trailer	6.3
Seating	2.9	Recommissioning	6.3
Troubleshooting	2.10	PONTOON TERMINOLOGY	7
PRE-LAUNCH & UNDERWAY	3		
Trailerage	3.1		
Launching	3.2		
Loading	3.4		
Anchoring	3.6		
Fueling Recommendations	3.6		

Pontoon ownership carries with it certain responsibilities to yourself as well as your passengers and the general public. Safety, common sense operation, careful maintenance, and compliance with the law will not hamper your boating pleasure, but will make boating more enjoyable.

TRAILERING

Selection of a trailer for your pontoon is extremely important. Your dealer can help you select the **proper** trailer for your intended use. Your trailer should be able to accommodate the weight of the pontoon, engine, and any other equipment that will normally be carried. Take the time to have your pontoon weighed while it is empty, and again when completely loaded including a full fuel tank. You will save a great deal of trouble by staying within the maximum load limits of the trailer.

Check the certification label on the frame of the trailer for the Gross Vehicle Weight Rating (GVWR). The total weight of your pontoon, engine, fuel, gear, and trailer should not exceed the GVWR.

If your towing vehicle is equipped with a weight-distribution hitch, it must be capable of handling the GVWR. The weight on the trailer should be evenly distributed and can be checked by determining the tongue weight.

Tongue weight is measured as a percentage of the total weight of the loaded trailer on its tongue. Ideal tongue weight is not less than five percent (5%) and not more than ten percent (10%) of the GVWR. For example, if the weight of the loaded trailer is 3000 pounds, the weight on the tongue should be more than 150 pounds but less than 300 pounds. Excessive tongue weight will cause the front end of the towing vehicle to sway. Insufficient tongue weight will cause the trailer to sway or fishtail.

▲ WARNING

WARNING: Improper trailer size and improper weight distribution can cause swaying and fishtailing that can result in extensive damage to the trailer, the pontoon, and the towing vehicle. Swaying and fishtailing are especially dangerous at higher speeds where they can become uncontrollable. Damage caused as a result of improper trailering is not covered under the Crestliner Pontoon Warranty.

All trailers with a GVWR of 1500 pounds or greater are required to have brakes. Requirements may vary from state to state, so check with your Crestliner dealer for additional information.

Trailer Guidelines

1. Be sure that the bunks displace a large amount of tube surface, and be sure the pontoon and equipment distribute evenly on the trailer.
2. Make sure your pontoon is properly tied down and a safety chain is used.
3. Check local and state laws concerning any trailer requirements.
4. Do not trailer with your Pontoon's convertible top up. It will be severely damaged. Use a mooring cover for extended trips.
5. You are required by state and federal laws to equip pontoon trailers with functional taillights and turn signals.

6. Some states require registration of pontoon trailers and license plates. Check with the Department of Motor Vehicles for regulations governing your particular state.
7. Crestliner recommends the use of an outboard motor support bracket while the pontoon is on the trailer. Be sure to remove the bracket prior to launching the boat
8. 4 pin vs 5 pin connector. Newer trailers have disc brakes with 5 pin connectors. The fifth pin is for disengaging the brakes when backing up. The five pin connector can be plugged into a 4 pin connector and all lights will work fine, but you may have to manually engage the "Back Up Position" feature on the side of the trailer coupler in order to back up. If you have a five pin connector on your vehicle, this will not be necessary.

CAUTION

CAUTION: Do not exceed these capacity ratings. An overpowered pontoon can become unstable, sometimes resulting in loss of control or capsizing. An overloaded pontoon can become sluggish and hard to handle. Overloading or overpowering can also increase the danger of swamping, particularly in rough water. In addition, overloading or overpowering is illegal under most state laws and the Crestliner Warranty is void if the owner exceeds the recommended capacity ratings.

LAUNCHING

Pre-launch Inspection

All Pontoons under 26-feet in length are required to have a capacity rating plate showing the recommended persons capacity as well as the actual weight capacity of the pontoon including persons, engine and gear. Also, on outboard models, the plate will show the maximum horse-

power which can be safely installed.

INSPECTION CHECKLIST

Before beginning your boating excursion, get a current weather report. If the weather will not be favorable, postpone your trip.

1. Inspect the tubes and propeller for damage, excessive dirt or marine growth which will affect your pontoon's performance and fuel efficiency.
2. Check the electrical system and navigation lights.
3. Check that all required safety equipment is on board and in good working condition. Examples include personal flotation devices (PFDs), horn, fire extinguisher, visual distress signals, etc. Take along a gallon of water.
4. Check that all other required equipment is on board. Examples include mooring lines, anchor lines, tool kit, etc.
5. Visually inspect engine for oil, fuel or water leaks; cracked hoses; defective belts; or other signs of engine problems. Check engine oil and battery water levels.

WARNING

WARNING: POISON! Batteries contain sulfuric acid which can cause severe burns. Avoid contact with skin, eyes or clothing. Wear goggles, rubber gloves and protective apron when working with a battery. In case of contact, flush with water at least 15 minutes. If swallowed, drink large quantities of water or milk. Follow with Milk of Magnesia, beaten egg or vegetable oil. Get medical attention immediately.

⚠ WARNING

WARNING: During charging, batteries produce gases which can explode if ignited. Explosion can shatter the battery. Acid can cause severe personal injury such as blindness. Keep flame, spark and smoking materials away from battery while charging. Charge battery in a well-ventilated area.

6. Check that all engine drains and petcocks are closed.
7. Check fuel level.

⚠ DANGER

DANGER: Fuel leaking from any part of the fuel system can lead to fire and explosion that can cause serious bodily injury or death. Inspect system before starting the engines. Do not smoke and keep open flames away when checking fuel system.

8. If launching from a trailer, remove the engine support bracket (if used), and tilt the drive up to the high tilt position to avoid damage during the launch.
9. Before backing your boat down the launch ramp:
 - Remove all stern tie-downs.
 - Properly secure all loose gear.
 - Inventory your safety equipment.
 - Load all personal gear.
 - Lock winch and trailer unit.
 - Disconnect trailer wiring from towing vehicle to prevent short circuits caused by submersion.

Launching Guidelines

NOTE: For more specific information, refer to your trailer owner's manual.

Here are some tips to remember when putting your pontoon in the water.

1. Unplug trailer light wires
2. Have an individual at the launch ramp give you directions. Back slowly down the ramp. If the trailer needs to be maneuvered to the right, turn the towing vehicle's steering wheel to the left. If trailer movement to the left is required, turn the steering wheel to the right. Always remember to launch your pontoon at a right angle to the shoreline.

NOTE: If you do not have experience in backing up with a trailer, **Practice**. Take your trailer to an open area and master using it before you get into a confined public or private launch site.

3. When the pontoon tubes are in several inches of water:
 - STOP the towing vehicle.
 - Leave manual transmission in gear or place automatic transmission in park.
 - Turn off the engine.
 - Set the hand brake.

NOTE: If you have a bunk trailer, the pontoon tubes must be deeper than several inches in the water before launching.

4. Place blocks behind the vehicle's back wheels.
5. Do not unclasp the winch cable from the bow eye until a mooring line has been secured to the pontoon. Attach one line to the bow and one line to the stern to help control the pontoon. See the **Mooring Lines**

information that follows for suggested securing procedures.

6. Launch the pontoon; move it down and OFF the trailer into the water. Secure the pontoon to the dock or have someone hold the mooring lines.
7. Lower the drive unit into the water.
8. Pull your towing vehicle away from the launch ramp.
9. Park only in designated areas. When parking, be sure your towing vehicle and trailer do not block other boaters from approaching the launch ramp or hinder their ability to maneuver a boat and trailer when launching.

Mooring Lines

The mooring lines you will use most often are the bow line, the stern line and spring lines as shown in Figure 3.1. Each line has a specific purpose. The bow line and the stern line secure your pontoon's bow and stern. The two spring lines keep your pontoon from moving forward or backward when you are moored alongside a dock.

Mooring lines must be long enough to secure your pontoon in any docking situation. For example, the length of the lines for a 16-foot pontoon should be at least 15 feet. An eye splice at the end of each line (shown on Figure 3.1) should be large enough to fit comfortably over bow or stern cleats.

NOTE: If you are mooring your pontoon in an area where tides are a consideration, be sure to leave slack in the lines to make up for the rise and fall of the water.

If you are mooring your pontoon for a short time, bow and stern lines may be the only lines you will need. If you are mooring your pontoon for a longer time or if the currents

are swift, you should use spring lines. The stern spring line leads from the pontoon's stern cleat forward to the piling or cleat on the dock. The bow spring line leads from the bow cleat aft to the dock. (See Figure 3.1.)

If you are mooring your pontoon in a slip, bow and spring lines, port and starboard, will keep your pontoon in position.

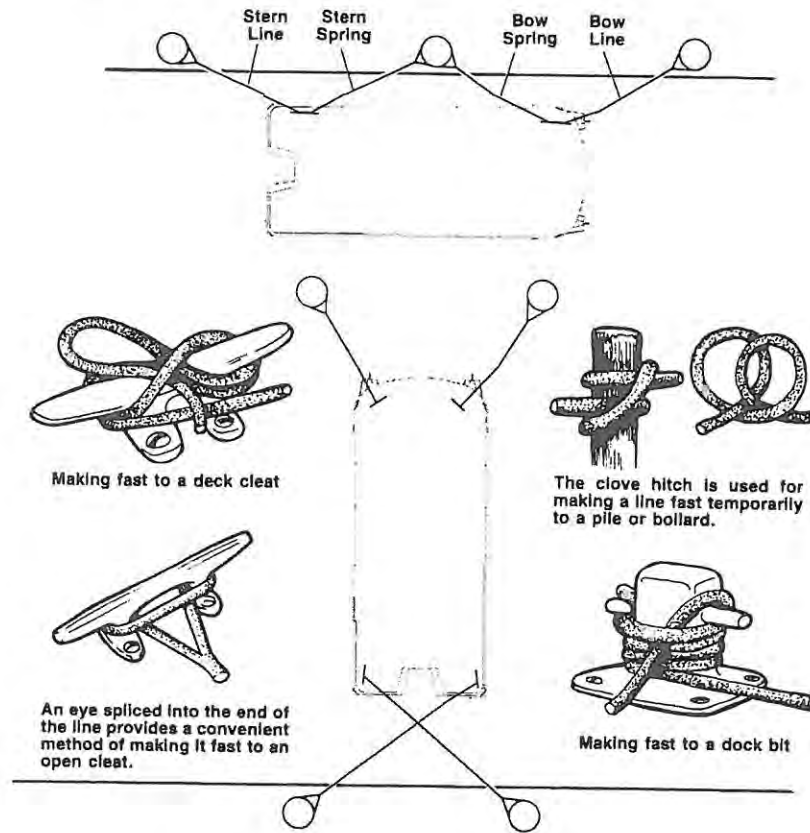

FIGURE 3.1 - MOORING LINES

LOADING

When loading your pontoon, remember to distribute the

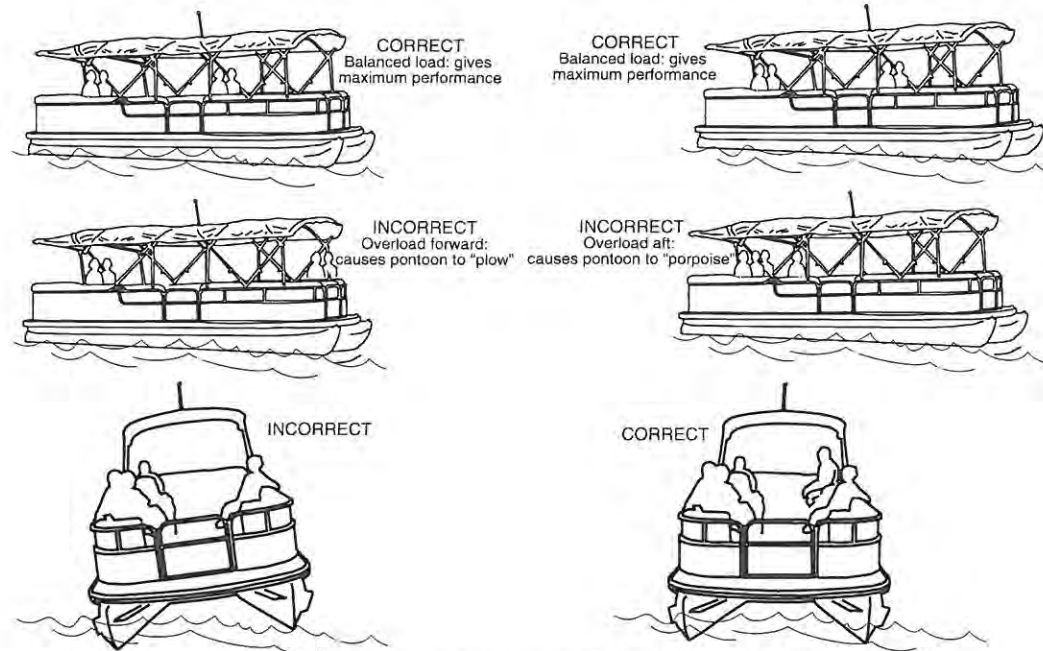

FIGURE 3.2 – LOADING PASSENGERS

load evenly. Keep the load low and do not overload. The capacity plate affixed to your pontoon states the maximum load capacity. The plate shows persons and gear in pounds that the pontoon will safely handle under normal conditions. The U.S. Coast Guard establishes these load capacity ratings.

When loading always step onto the pontoon, never board by jumping. Have someone on the dock pass your gear aboard. Secure all gear firmly so it will not move or interfere with operation of the pontoon.

Passengers should board the pontoon one-at-a-time and be seated. Passengers should remain seated during loading of the pontoon to maintain an even trim. Prohibit passengers from riding on the bow with feet hanging over the side, or riding while sitting on the stern or fences. Passengers should choose the proper seat based on the intended pontoon speed. (See information in chapter 2 on seating). Falls from moving boats are a major cause of fatal recreational boating accidents.

▲ WARNING

WARNING: Swivel seats may rotate suddenly while underway. Injury is possible if rotation causes occupant to fall to deck or fall overboard. At speeds greater than 5 MPH, occupy only designated seats. Before getting underway, secure swivel seats in base by turning to locked position.

IMPORTANT: The presence of the capacity plate does not relieve the pontoon operator from the responsibility of using common sense or sound judgement. Turbulent waters and adverse weather conditions will reduce the maximum load capacity rating of the pontoon.

IMPORTANT: When passengers are seated in the bow area, care should be taken so as not to obstruct the driver's vision.

ANCHORING

1. The weight of the anchor and diameter of anchor line should be governed by the size and weight of your pontoon. Obtain advice from your dealer before purchasing an anchor.
2. Keep anchor secure while underway to prevent damage or injury due to sudden shifting in the pontoon's attitude.
3. Make sure the anchor line is secured to the bow eye or bow cleat. Never tie to a rail, rail fitting, or other hardware which is not meant to support this stress. Never tie anchor to the stern unless you also are using a bow anchor. Anchoring by the stern only could cause wind driven waves to enter your pontoon.
4. Use two or more anchors if anchoring overnight or for extended periods. If not using two anchors, make certain there is sufficient clearance for your pontoon to swing in a full circle to prevent damage in case of shifting winds.
5. Make certain you have enough anchor line (or scope) for the depth of water. Your anchor line should be 6 to 7 times the depth of water anchored in. For example, you are in 20 feet of water, so use 120 to 140 feet of anchor line.

Dropping Anchor

1. Have a crew member carefully lower the anchor. Keep slight tension on the anchor while lowering and maintain your tension after anchor reaches bottom.
2. Maneuver the pontoon backwards slowly until the proper length of anchor line is handed out.
3. Fasten the anchor line around the tube eye or deck cleat. Anchor flukes should dig in and catch.

Watch for anchor drag by checking shoreline landmarks at the time the anchor is dropped and one-half hour later. If the pontoon has drifted away from these reference marks, the anchor is dragging and must be reset.

Weigh (pull in) Anchor

1. It is recommended to have the engine running when you pull in anchor.
2. Slowly maneuver the pontoon forward to reduce tension on the line and make retrieval of the anchor line easier.
3. Pull in the length of anchor line until the line is vertical. Pull firmly to lift the anchor's shank and free the flukes from the bottom.

If the anchor becomes stuck, attach the vertical line to the mooring cleat. Wave action on the bow may lift flukes from the bottom and free the anchor. If the anchor is still stuck, feed out a few feet of line and attach it to the bow cleat. Maneuver the pontoon around the anchor, keeping the line firm. Locate an angle that will pull the anchor free.

FUELING RECOMMENDATIONS

Your pontoon is equipped with a gasoline fuel system. **Please take time to read and understand all the fuel related information and warnings regarding gasoline and your pontoon in the engine owner's manual.**

NOTICE

GASOLINE RECOMMENDATIONS
Minimum octane rating of 87 (R+M)/2

The use of improper gasoline or additives can damage your fuel system and is considered misuse of the system. Damaged caused by improper gasoline or additives
WILL NOT be covered under warranty.

Care should be taken to select fuels having the octane rating recommended for the engine, as indicated in the owner's manual, for proper operation.

Ethanol-Blended Fuels

Ethanol is an oxygenated hydrocarbon compound that has a high octane rating and therefore is useful in increasing the octane level of unleaded gasoline.

The fuel-system components of your Mercury engine(s) have been tested to perform with the maximum level of ethanol-blended gasoline (10% ethanol) currently allowed by the EPA in the United States.

Special precautions should be considered with the use of fuel containing ethanol in your system. Fuels with ethanol can attack some fuel-system components, such as tanks and lines, if they are not made from acceptable ethanol-compatible materials. This can lead to operational problems or safety issues such as clogged filters, leaks or engine damage.

Your pontoon was manufactured, and shipped from the factory, with E10 ethanol-compatible materials. Before introducing gasoline with ethanol into your fuel tank, ask your dealer if any components have been added or replaced that are not recommended by Crestliner, Mercury or may not be ethanol-compatible.

Filling The Tank

It is best to maintain a full tank of fuel when the engine is not in use. This will reduce air flow in and out of the tank due to changes in temperature as well as limiting exposure of the ethanol in the fuel to humidity and condensation.

Phase Separation

Humidity and condensation create water in your fuel tank which can adversely effect the ethanol blended fuel. A condition called phase separation can occur if water is drawn into the fuel beyond the saturation point. The presence of water in the fuel beyond the saturation level will cause most of the ethanol in the fuel to separate from the bulk fuel and drop to the bottom of the tank, significantly reducing the level of ethanol in the fuel mixture in the upper level (phase). If the lower level (phase), consisting of water and ethanol, is deep enough to reach the fuel inlet it could be pumped directly to the engine(s) and cause significant problems. Engine problems can also result from the reduced ethanol/fuel mixture left in the upper phase of the tank.

Example of Phase Separation

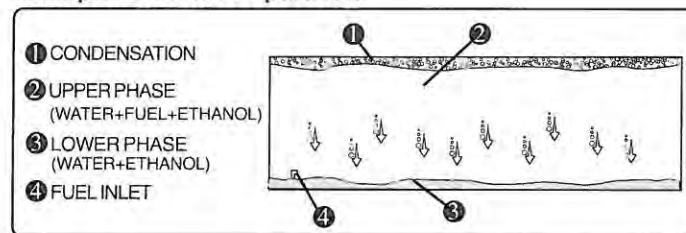

Additives

There is no practical additive known that can prevent or correct phase separation. The only solution is to keep water from accumulating in the tank.

If phase separation does occur, your only remedy is to drain the fuel, clean and dry the tank completely and refill with a fresh, dry load of fuel.

Fuel Filters

Mercury already provides the appropriate level of filtration to protect the engine from debris. The addition of another *inline* filter to the system will create a possible flow restriction that can starve the engine(s) of fuel.

As a precaution, it is advisable to carry extra *on-engine* filters in case filter plugging from debris in the fuel tank becomes a problem during boating.

Maintenance

Periodically inspect for the presence of water in the fuel tank. If any is found, all water must be removed and the tank completely dried before refilling the tank with any fuel containing ethanol.

Storage

Long periods of storage and/or non-use, common to pontoons, create unique problems. When preparing to store a pontoon for extended periods, of two months or more, it is best to completely remove all fuel from the tank. If it is not possible to remove the fuel, maintaining a full tank of fuel with a fuel stabilizer added to provide fuel stability and corrosion protection is recommended.



The use of fuels containing ethanol higher than 10 percent (E-10) can damage your engine and/or fuel system and will void the warranty.

E-85 FUELS COULD SERIOUSLY DAMAGE YOUR ENGINES AND MUST NEVER BE USED.

REFER TO THE ENGINE MANUFACTURER'S MANUAL IN YOUR OWNER'S MANUAL PACKET FOR COMPLETE INSTRUCTIONS AND WARRANTY.

⚠ WARNING

WARNING: Use only marine fuel hose marked "USCG Type A" if replacement is necessary. Inspect all fuel distribution lines often to reduce the risk of fire hazard.

If only fuel containing alcohol is available, or the presence of alcohol is unknown, you must perform more frequent inspections for leaks and abnormalities. Any sign of leakage or deterioration requires replacement before further engine operation.

Preliminary Guidelines

1. Safely secure your pontoon to the dock.
2. Do not smoke, extinguish all open flames, STOP all engines and other devices that could cause sparks, **including the bilge blower**. Do not use electrical switches or accessories, shut OFF all stoves that may produce a spark or flame.

⚠ WARNING

WARNING: Vapor from spilled fuel is heavier than air and will flow to the lowest part of the pontoon. Ventilate before starting.

3. Close compartments to prevent the accumulation of fuel vapors.
4. Ensure a fire extinguisher is readily available.
5. Remove portable fuel tanks from the pontoon when filling. Wipe any spilled fuel from portable tanks before placing them in pontoon.

6. Do not store fuel in areas that are not adequately ventilated.

DANGER

DANGER: Gasoline vapors are highly explosive. Follow all safety precautions before, during, and after fueling.

7. Use only fuel lubricants recommended by the engine manufacturer.

Fueling

WARNING

WARNING: Do not use E85 fuel in this product. Do not use fuel containing more than 10% methanol or ethanol alcohol by volume.

NOTE: See your dealer or the sales literature to determine your pontoon's fuel tank capacity.

1. Always fuel in an area supplying sufficient lighting conditions. Gasoline spills are unnoticeable under poor lighting or in darkness.
2. Remove the fuel fill plate.
3. Insert the fuel supply nozzle, keeping the nozzle in contact with the fuel fill plate while fueling, to guard against static produced sparks.

IMPORTANT: When fueling or having your pontoon fueled by an attendant, be sure the waste pumpout plates are not mistaken for the fuel fill plate.

4. Stand away from the fuel tank vent and fill plate during fueling. Splash-back may occur and can be an eye irritant as well as a fire hazard.
5. *Avoid spillage.* Wipe any excess fuel immediately.
6. After pumping approximately 10 gallons of fuel into the fuel tank, inspect the engine and fuel tank area for any signs of fuel leakage. Continue fueling if no leaks or other problems are detected.
7. If fuel cannot be pumped in at a reasonable rate, check for fuel vent blockage or kink in the line.

After Fueling

1. Replace the fuel fill plate and wipe up any fuel spillage. Fuel allowed to remain on the pontoon's painted surface or decals may damage or degrade these surfaces. Discard any rags that you may have used to wipe up fuel spillage in a safe place.
2. With a stern drive, open the engine compartment and all other compartments that were closed during fueling. Inspect for the odor of fuel vapors and visible fuel leakage. Any sign of fuel leakage or any indication of vapors must be investigated and corrected before starting the engine.
3. With a stern drive, run the bilge blower for at least five (5) minutes before starting the engine. Continue to run the bilge blower until the pontoon is underway and has reached its cruising speed.

GETTING UNDERWAY

Instrumentation

The gauges described are not available on all Crestliner models. Consult with your dealer for various applications. Your dealer can also advise you on the normal readings of the gauges at the time of delivery of your pontoon. This will provide you with a reference point for the life of the engine. Keep in mind some gauges tend to fluctuate which is not uncommon. But when operating your pontoon, investigate all gauges that show a greater or less than normal reading.

Fuel Gauge

Displays the amount of fuel contained within the fuel tank. The most accurate reading of the fuel gauge is at idle speed when your pontoon maintains an approximately level position. Underway, the fuel gauge will usually indicate a higher fuel level than is actually in the tank due to the bow of the pontoon being higher than at rest. Since gauge readings are approximate, they should be compared to the hours of use versus known fuel consumption, or gallons per hour (GPH). The most common practice of good fuel management is the one-third rule. You use one-third of your total fuel on board to travel to your destination and one-third in returning. The remaining one-third in the fuel tank should be reserved for emergencies.

Oil Pressure Gauge

The oil pressure gauge (stern drive models only) will reflect most, if not all, serious problems that may occur within your engine. A pre-set valve in the oil pump controls the maximum oil pressure. If a complete loss of oil pressure occurs, **stop the engine immediately**. Serious damage to the engine can result after loss of oil pressure if the engine continues to run. Check the engine oil level and fill if low. If oil level is full and gauge reading is low, contact your Crestliner dealer or a qualified mechanic to rectify the

problem. **Do not restart the engine until correcting the problem.** See engine manufacturer's specifications for correct pressure ranges.



Tachometer

Displays the number of revolutions per minute (RPM) that the engine is running. The gauge displays increments of 100. The tachometer will show the RPMs necessary under various engine operating conditions. Consult with your Crestliner dealer if you require additional information. Do not exceed engine manufacturer's recommendations.

Speedometer

Indicates boat speed in MPH (miles per hour). The accuracy of this instrument depends on the placement and cleanliness of the pickup tube. The pickup tube should be tilted up for trailering or shallow water, and down while underway.

Temperature Gauge

Displays the temperature of the engine water cooling system. This gauge should always be checked right after starting the engine. Marine engines draw external water, circulate it through the heat exchanger on the engine, and expel it overboard through the exhaust system. If the temperature gauge shows a hot condition, **stop the engine**

immediately. Refer to your engine owner's manual for instructions and corrective action.

Voltmeter

Displays battery voltage. Under normal engine running conditions (1000 RPMs or higher), the voltage will range between 11 and 14 volts when the alternator is charging. With the engine OFF and ignition key or switch ON a fully charged battery is indicated by a high voltmeter reading. Significantly higher or lower readings show a battery problem, alternator malfunction, or heavy drain on the battery. You should check the charging system and battery system for these higher or lower readings. An oscillating reading shows a loose voltage regulator connection or loose belts. Displayed low voltage readings after stopping engine shows a bad battery or heavy load on the battery. Refer to your engine owner's manual for proper gauge readings.

Power Trim Gauge

Indicates the relative position of the drive unit. This should be read carefully as it does not show position of the drive unit in degrees. Proper trim should be indicated by bow attitude and engine RPM.

CONTROLS

Steering Control

It is important that you get the "feel" of your pontoon's steering system. Steering does vary from pontoon to pontoon depending on engine type and horsepower, water and wind condition, and load.

Turn wheel from full left to full right and make certain the engine or drive unit is turning correctly. The system should run freely and smoothly.

Many I/O models are equipped with power steering. Check

the fluid level and belt tension before starting. The cable output end of the steering system should be kept clear of fuel lines, control cables, electrical wiring, and other on board gear when the engine is moved through its full operating range.

Some outboard models are equipped with hydraulic steering. Check the steering fluid level before starting the engine. Be sure to read the hydraulic steering system information supplied with your pontoon for complete maintenance procedures.

A manually adjustable trim fin is provided on all stern drive engines and most outboard engines. Follow the instructions provided by the engine manufacturer for proper adjustment. This trim fin, when correctly adjusted, will help reduce steering effort through the entire trim range.

To maintain a straight course, keep at least one hand in control of the steering wheel at all times while underway.



CAUTION: Do not over-tighten bolts or nuts that have been previously tightened. Use only manufacturer's specifications and parts when repairing or replacing steering parts.

Throttle/Shift Control

NOTE: For optional or dealer installed controls, see the information supplied by the manufacturer of the control.

IMPORTANT: Allow the engine to warm up before engaging the shift control. Monitor all instruments while engine is idling during warm up. See the engine manufacturer's specifications for proper operating ranges.

Place the throttle/shift control handle in the NEUTRAL position. The engine should not start unless the control is in NEUTRAL, or the NEUTRAL safety switch is activated.

CAUTION

CAUTION: The throttle on a hand operated remote control does not return to idle as on an automobile, when the pressure is released. Make sure you can reach the control lever quickly at all times when the engine is running.

The throttle/shift control regulates the RPM of the engine. Forward movement of the throttle increases the RPM of the engine. It also increases pontoon speed through the water when the engine is in either forward or reverse gear. The throttle control also acts as the gear shift lever to control the forward and aft movement of the pontoon.

Moving the throttle forward from the neutral position engages the shifting mechanism causing the pontoon to move forward. Continuing the forward movement of the throttle will increase engine RPM, and cause the pontoon to move faster in a forward direction.

Moving the throttle aft from the neutral position reverses the shift mechanism causing the pontoon to move backward. Continuing the aft movement of the throttle will increase engine RPM and cause the pontoon to move faster in a backward direction.

When maneuvering at low speeds you can reverse (move throttle forward or aft) the shift mechanism. This will result in a braking action.

CAUTION

CAUTION: When shifting between forward and reverse, always pause in neutral for a few seconds before reversing the rotation of the propeller(s). This will prevent unnecessary damage to the drive system.

WARNING

WARNING: High speed acceleration in reverse can create a wake that could wash over the transom and flood the pontoon pod.

Stopping-You do not have brakes on a pontoon.

Practice stopping maneuvers and learn early how your pontoon reacts. From forward motion, pull back the throttle towards NEUTRAL. Depending on your speed, the distance the pontoon travels until it comes to a complete stop will vary. The ability to measure this distance will only be acquired through experience.

To aid in a quicker stop, the throttle/shift can be moved to the reverse position once it has been returned to NEUTRAL.

NOTE: Be certain that all persons who operate the pontoon are acquainted with all facets of pontoon handling.

STARTING PROCEDURES

The operation and maintenance manual supplied with your engine provides pre-start, starting, and cold-starting instructions. The following information is merely a guide and not intended to explain in detail all starting procedures and instructions. **Refer to your engine owner's manual.**

Preliminary Checks

1. Secure pontoon to the dock before attempting to start engine. The boat should be kept secure until the engine is running and warmed up.
2. Check engine oil level, power steering and power trim fluid levels.

3. Check fuel supply to ensure you have enough fuel for your expected travel plan.
4. Check for stern drives the engine compartment. Inspect for fuel odors and visible leaks in the fuel, oil, coolant, exhaust, and power steering systems.

DANGER

DANGER: Gasoline vapors are highly explosive. To prevent possible explosion and fire, check the engine and fuel compartments before each engine start for the accumulation of fumes or fuel leakage.

5. Always operate the bilge blower (if so equipped) for at least five (5) minutes before and while starting the engine, and anytime you are operating your pontoon below cruising speeds.
6. Make sure the throttle is in the neutral position. Check that the drive unit is in the water and not in the raised trailering position.
7. Make sure passengers seated in the bow area do not obstruct the driver's vision.

Starting

1. Check all electrical systems and navigational lights.
2. For stern drives, Run bilge blower (if so equipped) for five (5) minutes before starting engine.
3. When cold starting your pontoon, advance the throttle several times and leave it in the SLOW/START position. This will actuate the carburetor accelerator pump and feed fuel to the engine. Turn ignition key to START position.

NOTE: Engine will not turn over if throttle is not in the neutral position.

CAUTION

CAUTION: Do not continuously operate starter for more than 15 seconds without pausing. Allow starter to cool at least three (3) minutes between start attempts.

4. If engine fails to start, wait approximately three (3) minutes. Move throttle only once to the maximum position then back to the neutral position, and try to start engine again.
5. When engine is cold, run engine approximately one (1) to two (2) minutes at fast idle speed (1200 to 1500 RPM).
6. Once engine has warmed up, check temperature gauge to ensure engine temperature stays within optimum range. If temperature reading is abnormally high, **stop engine immediately**, and inspect for cause of high reading.
7. With engine running, voltmeter should show a reading between 11 and 14 volts.
8. Check steering operation. Turn steering wheel to full port and to full starboard while observing outdrive movement.
9. Inspect for fuel odors and visible leaks in the fuel, oil, coolant, exhaust, and power steering systems.
10. Make sure pontoon is still securely moored to the dock and engine is idling at 600 to 800 RPM. Then move the throttle forward and then aft, and back to neutral to check for proper operation of the shifting motion.

⚠ DANGER

DANGER: Engine and generator exhaust systems produce carbon monoxide (CO), a poisonous gas which is odorless, colorless, and heavier than air. Direct prolonged exposure can result in CO poisoning that may be harmful or fatal. Indications of excessive exposure to CO concentrations may include nausea, dizziness, and drowsiness.

To prevent excessive exposure and reduce the possibility of CO accumulation in the cockpit areas of the pontoon, the operator should provide adequate ventilation in each of these areas. See Section 1 for information about Carbon Monoxide DANGER.

Acceleration

⚠ CAUTION

CAUTION: Acceleration at full throttle is not recommended before the engine “break-in period” has been completed. This “break-in period” also coincides with the engine “twenty (20) hour check-up”. Therefore, full throttle acceleration should not be attempted until your engine has surpassed this usage time. Refer to engine owner’s manual.

Before accelerating, make sure all passengers are in the proper seats. (See seating information in chapter 2).

⚠ WARNING

WARNING: Swivel seats may rotate suddenly while underway. Injury is possible if rotation causes occupant to fall to deck or fall overboard. At speeds greater than 5 MPH secure swivel seats by engaging locking mechanism. If seat is not equipped with locking mechanism, do not occupy seat at pontoon speeds exceeding 5 MPH.

Before accelerating your pontoon, check the entire area to make sure you have a clear, safe path.

TRIMMING

TILT/TRIM Control Switches

1. The standard trim control switch is located on the control lever handle.
2. The switch controls the “trim” of your pontoon under various conditions, loads, and uses. Proper trim is very important in boating. Trim refers to the angle of the lower unit in relation to the bottom of the pontoon.
3. Note: Pontoon’s can be more sensitive to weight distribution than boats. Trim angle can also be effected by load distribution.
4. In the case of low or heavy bow attitude, the lower unit is normally trimmed too far under or forward. Trim the unit out or up to correct this situation.
5. If the bow is too high or steering is difficult, your lower unit could be trimmed up too far. Trim IN to correct.
6. A good practice is to get underway (especially when fully loaded or pulling a skier) with the unit trimmed all the way under or IN. After the pontoon is underway, adjust the trim out slightly to obtain the proper bow attitude and engine RPM.
7. Trim also affects propeller selection and fuel efficiency. All models should be “propped” to be in the upper half of the maximum RPM range with the pontoon lightly loaded and the lower unit trimmed up to maximum. This configuration will allow the engine to operate within the recommended RPM range with a heavy load.

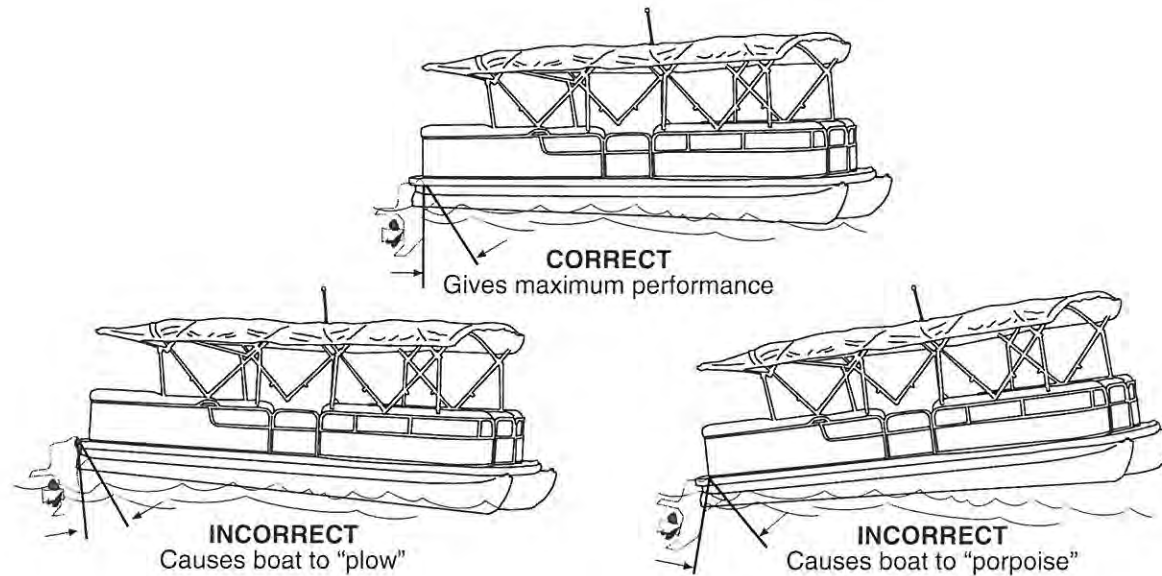

FIGURE 3.3 – TRIM / MOTOR ANGLE

The lower unit should never be trimmed up to a point where the propeller cavitates (or slips). A rapid increase in engine RPMs is evidence of cavitation. If this occurs accidentally while running at full throttle, immediately lower the lower unit trim and reduce the throttle until the slipping stops. Have your dealer reset the trim limit switch to avoid over trimming in the future.

If the prop slips at lower planing speeds, the lower unit may be trimmed too high. Immediately lower the lower unit until the prop “grabs” again to restore efficiency.

8. The high-tilt trailering position of the stern drive is controlled by a separate switch which is located on the dash or switch panel, except when optional controls

⚠ DANGER

DANGER: Excessive trim will decrease maneuverability, change steering characteristics, and may cause cavitation.

are provided. *Do not activate this switch while underway.* This can severely damage the lower unit.

NOTE: Refer to your lower unit instruction manual regarding the power trim controls installed on your pontoon.

On outboard engines without power trim, the trim angle can be controlled by using the following “Rule of Thumb”: If the bow runs low or heavy in the water, move the unit out one or two pin hole settings. If the bow runs too high or light in the water, move the unit in towards the transom one or two pin hole settings.

ADDITIONAL UNDERWAY INFORMATION

- Be sure to run the bilge blower whenever the boat is operated under cruising speed. (Stern drives only).
- Keep all bilge blower and engine compartment vents free of obstructions to allow proper ventilation. (Stern drives only).

- You are responsible for any damage or injury caused by your pontoon's wake. Observe no wake speed zone warnings. Operate your vessel with regard for the safety of other boats and people in your boating area.
- Keep your engine well tuned to decrease exhaust hydrocarbon emissions that pollute the air and water.
- Be a good boating neighbor. Sounds can carry a long distance over water, especially at night. Loud conversations and music can be disturbing to others as can excessive engine noise. Check with local authorities regarding any noise restrictions.

ENGINE SHUT DOWN

1. Turn OFF ignition switch.
2. Turn OFF all other switches.
3. Raise the lower unit to the high tilt or trailer position. This is to avoid damage to the propeller or lower unit before removing the pontoon from the water.
4. After securing the pontoon to the trailer (if removing from water), remove the drain plug and drain the bilge. If pontoon is being secured to floating dock, boat house, etc., and will remain in water, drain the bilge by using the pontoon's bilge pump (stern drive model only).

RELOADING YOUR PONTOON

1. Back the trailer into the water.
2. When the trailer is in several inches of water:
 - STOP the towing vehicle.

- Leave manual transmission in gear or place automatic transmission in park.
- Turn off the engine and set the hand brake.

NOTE: If you have a bunk trailer, the trailer may need to be more than several inches in the water before loading.

3. Tilt the pontoon's lower unit up to the high tilt position to avoid damage while loading.
4. Pull pontoon up onto trailer and secure safety cable.
5. Start engine on towing vehicle and pull trailer out of water to boat securing area.
6. Use tie-downs to secure pontoon on trailer.
7. Remove the drain plug (stern drive only).
8. Make sure lower unit is raised and secure.
9. Wipe tubes down to prevent water spots and keep tubes clean.
10. Make sure everything in the pontoon is secure or tied down. Place anything loose in towing vehicle.
11. Reconnect trailer lights. Check that lights are working.
12. Check for and remove any aquatic vegetation.

HAULING OUT

1. Prepare before approaching ramp.
2. Secure fuel lines (outboard).
3. Tilt outboard or stern drive unit up.

4. Back trailer down ramp.
5. Set brake and place chocks behind wheels of tow vehicle.
6. If trailer has tilt mechanism, move it to up position.
7. Guide pontoon onto trailer. Use bow and stern lines to help

⚠ DANGER

DANGER: Excessive trim will decrease maneuverability, change steering characteristics, and may cause cavitation.

8. Hook winch cable to pontoon bow eye. Use gloves to handle cable
9. Keep clear as pontoon is cranked onto trailer.
10. Open drain plugs while pontoon is tilted.
11. Rig sufficient tiedowns to temporarily secure pontoon to trailer.
12. Remove chocks and drive tow vehicle and trailer from ramp.
13. If in salt water, wash down hull and trailer with fresh water as soon as possible.
14. Inspect propeller for nicks or other damage.
15. Wipe hardware, including canvas snaps, with clean, soft cloth and spray with demoisurant.

16. Complete tiedown and secure gear for road. (See *Using Trailer—Pre-trip Checklist*).

MANEUVERING WITH TRAILER

1. Start with the basics—accelerating, slowing, stopping smoothly and steadily.
2. Increase distance from vehicle ahead.
3. Do not pass other vehicles until you feel comfortable pulling trailer.
4. Maintain steady control in the wake of large trucks and buses.
5. When turning, signal your intention well ahead of time.
6. Swing a little wider than you would turn without a trailer.
7. Stop every hour or so to inspect wheel bearings, connections, tiedowns, cover and other fastenings.
8. Back up slowly with a trailer:
 - Practice with an empty trailer in an empty parking lot.
 - Get the feel of backing straight. Small, S-shaped steering corrections will be needed.
 - When you're ready to turn while going backward, put your hands on the bottom of the vehicle's steering wheel. The trailer turns opposite the towing vehicle's direction. By moving the bottom of the steering wheel in the direction you want the trailer to go, the towing vehicle will go the opposite way.

- As the trailer starts to turn, move the bottom of the steering wheel back to the center. The trailer will continue to turn at an increasing rate. Move the bottom of the steering wheel opposite the direction of the trailer in order to slow the turning rate.
- If the trailer turns too sharply (“jackknifes”) or does not turn enough, stop, pull ahead and try again.
- Practice, practice, practice!

PRE-TRIP CHECKLIST

- Trailer wheel bearings—greased
- Trailer and tow vehicle tires—correct pressure
- Trailer and tow vehicle lights and brakes—operating
- Spare tires, jacks, parts—usable
- Pontoon steering mechanism—lubricated
- Pontoon connections and linkages—tight
- Tongue weight—5 to 10 percent of total boat and trailer weight
- Tiedowns—secured
- Winch line—taut
- Winch anti-reverse gear—engaged
- Turnbuckle/safety hook—secured
- Motor—in traveling position
- Coupler—tight

- Hitch ball—greased lightly to reduce friction
- Safety chains—crossed under trailer tongue and secured
- Tongue jack—raised
- Spring bars (for weight-distributing hitch)—adjusted
- Pontoon canvas—down and secured
- Pontoon cover—secured
- Boating gear—secured
- Registration, proof of insurance, other documentation—present

Table of Contents

LINE DRAWINGS	i	PRE-LAUNCH & UNDERWAY (CONT.)	3
WELCOME ABOARD	1	Getting Underway	3.10
Owner's Manual Structure.....	1.1	Controls.....	3.11
Responsibilities	1.2	Starting Procedures	3.12
Pontoon Records	1.3	Trimming	3.14
Warranty.....	1.3	Additional Underway Information	3.15
Crestliner Pontoon Log (Form).....	1.4	Engine Shut Down	3.16
Crestliner Cruise Log (Form)	1.5	Reloading Your Pontoon.....	3.16
Crestliner Fuel Usage Log (Form).....	1.6	MAINTENANCE	4
Navigational Aids Chart	1.8	Service & Maintenance Schedule	4.1
Boating Safety.....	1.9	CARE & APPEARANCE	5
Safety Underway.....	1.12	Tube and Fence Care.....	5.1
Weather	1.15	Upholstery.....	5.2
Safety Equipment.....	1.16	Windshields and Windows	5.2
Additional Recommended Equipment.....	1.18	Carpeting	5.3
Boating Laws & Regulations	1.18	Canvas	5.3
Illegal to Dump	1.19	WINTERIZATION & STORAGE	6
SYSTEMS & COMPONENTS	2	Prior to Storage.....	6.1
Safety Labels	2.1 - 2.2	Engine.....	6.1
Systems	2.3	Livewell	6.2
Equipment.....	2.5	Interior Cleaning.....	6.2
Livewell	2.8	If You Store Your Pontoon on a Trailer	6.3
Seating.....	2.9	Recommissioning.....	6.3
Troubleshooting.....	2.10	PONTOON TERMINOLOGY	7
PRE-LAUNCH & UNDERWAY	3		
Trailering	3.1		
Launching	3.2		
Loading	3.4		
Anchoring.....	3.6		
Fueling Recommendations	3.6		

This section contains a general maintenance schedule and troubleshooting chart. If you do not fully understand the information contained within this section of your owner's manual, or any of the related product service manuals, contact your dealer. Crestliner recommends maintenance be performed at an authorized Crestliner dealer. The following information is of a general nature.

NOTE: Only use approved marine replacement parts available from your Crestliner dealer.

SERVICE & MAINTENANCE SCHEDULE

The following time intervals are intended to be used as a guide under normal operating conditions. Other operating conditions may warrant shorter time intervals. Instructions for performing listed items can be found in either your owner's manual, installed equipment manuals, or by contacting your Crestliner dealer.

Time Interval Description

- 1 = 48 hours after launch
- 2 = 25 hour check during each boating season
- 3 = Twice during boating season/Every 6 months/Every 100 hours of operation
- 4 = Beginning of boating season/Every 12 months/Every 200 hours of operation

Maintenance Terminology

Check - to observe for satisfactory conditions, accuracy, safety or performance.

Inspect - to examine closely, in critical appraisal, while testing or evaluating components or systems.

Lubricate - to apply a lubricant (oil, grease, etc.) as specified for reducing friction, heat and wear between solid surfaces.

ITEM	TIME INTERVALS			
	1	2	3	4
Engine, Lower Unit or Outboard				
Perform engine and drive unit maintenance as recommended by manufacturer.				
Inspect:				
Cooling system hoses & clamps		X	X	X
Drive belt tension (all)			X	X
Check:				
Prop for trueness				X
Propellers				X

ITEM	TIME INTERVALS			
	1	2	3	4
Engine & Drive System				
Clean:				
All gauges				X
Spray ignition switch w/contact cleaner				X
Control System				
Adjust throttle and shift		X		X
Test "neutral" safety switch				X
Lubricate cables and control				X
Steering System				
Inspect linkage and connections			X	X
Adjust steering		X		X
Lubricate steering system				X
DC Electrical System				
Inspect:				
Battery connections			X	X
Battery cable				X
12V wiring and connections				X
Check:				
Battery water level		X	X	X
Operation of 12V electrical equipment		X		X
All receptacles and connections			X	X
Bilge blower operation (stern drive only)		X	X	X

ITEM	TIME INTERVALS			
	1	2	3	4
Fuel System				
Inspect:				
For fuel leaks and condition of fuel hoses		X	X	X
Fuel pump & filter		X	X	X
Fuel tank			X	
Clean fuel filter		X	X	X
Ventilation & Drainage (stern drive only)				
Check:				
Operation of bilge pump(s)		X		X
Clean:				
Vent system			X	X
Bilge pump(s)		X		X
Exterior Equipment				
Check:				
Clean navigational lights			X	X
Seating & Canvas				
Clean upholstery				X
Wash canvas				X
Pontoon Tube & Deck Components				
Check rail and seat fastenings				X
Clean pontoons			X	X
Wax fences and all non-tread areas				X
Inspect areas for damage				X
Perform minor touch-up repairs				X

This chapter includes recommendations for cleaning the aluminum, hardware, fabrics, vinyl, and carpeting on your pontoon. Although household cleaners may be used, they should be used in small quantities. Cleaners containing chlorine, solvents, or petroleum may damage your pontoon's components and are a pollutant if they get into the water. In addition, cleaners containing phosphates encourage algae blooms. Mixing cleaners can cause harmful chemical reactions. Use citrus-based cleaners or the cleaners recommended. Check with your dealer for additional information.

Properly used and maintained, your Pontoon will give you years of service and enjoyment. By keeping your pontoon "shipshape", you will be doing more than protecting your investment; you will also ensure good performance and safety on the water.

The first step in ensuring good performance is keeping your pontoon clean, particularly below the waterline where a build up of scum, algae, or other marine growth can rob you of performance and fuel efficiency.

NOTE: Before attempting to use a particular cleaning solution or method for cleaning, test the material to be cleaned in a hidden or inconspicuous area for possible adverse reactions.

CAUTION

CAUTION: Wire brushes, scouring pads, or other abrasive type materials/solutions should never be used on the tubes and fences of your pontoon. They create small scratch marks that will collect marine growth and other foreign materials.

TUBE AND FENCE CARE

The finish on your pontoon is a baked on paint system and with proper care, will last for many years, retaining its lustrous appearance. Algae, forms of marine growth, and barnacles (in salt water) are extremely hard to remove once firmly attached to the bottom of your tubes. To avoid attachment of barnacles or marine plant life, it is recommended you wash the bottom of your tubes after every outing. In addition, it is a good idea to completely hose down the pontoon after use, especially in salt water areas. Consult your dealer for deck and hull commercial cleaners and their use.

Once your deck and tubes have been cleaned, (except for heavy grime or oil, a mild detergent and water will suffice—DO NOT USE ABRASIVES) you are ready for a wax application to bring back the original sheen of your tubes. Ask your Crestliner dealer to recommend a good commercial product.

It is a good idea to wax your pontoon at least twice a year. Keep the interior and exterior of your pontoon in nice condition, and inspect your pontoon regularly to keep minor problems from becoming major ones. REMEMBER, AN OLDER PONTOON IN NEARLY NEW CONDITION RETAINS A HIGH RESALE VALUE.

Hardware and Fittings

Chrome, stainless steel, and aluminum hardware should be cleaned with water and a cloth, followed with either an application of commercial aluminum or chrome cleaner. For excessively dirty or oily hardware, use alcohol. AVOID THE USE OF DETERGENTS OR ABRASIVES WHEN CLEANING HARDWARE.

Inspect all hardware and fittings to make sure they are secure. All screws, bolts, clamps, cleats, etc., must be tight.

UPHOLSTERY

Your pontoon's seats and vinyl upholstery should be kept as clean as the exterior finish to prolong life and beauty.

Seat Coverings & Vinyl

The seat coverings and vinyl trim are made of temperature resistant vinyl and made to withstand the effects of sun, heat, rain, and other outdoor elements under normal conditions. It is still important to clean and care for it. Many substances may stain the vinyl if left on for a period of time. Remember to remove any such contaminants and clean vinyl immediately.

1. Always try to clean up spills quickly to prevent staining.
2. Clean dirt and smudges with mild soap and warm water. If necessary, scrub with a soft bristle brush to remove dirt from textured vinyl. Dry with a soft, lint-free cloth or towel.
3. Certain household cleaners, powdered abrasives, steel wool and industrial cleaners can cause damage and discoloration and are not recommended. Dry cleaning fluids and lacquer solvents should not be used as they will remove the printed pattern and gloss. Waxes should be used with caution. Many contain dyes or solvents that can permanently damage the protective coating.
4. Periodic applications of a vinyl protection solution will help keep vinyl clean and pliable. **Follow instructions provided by vinyl manufacturer.** Check cleaning

solution labels before using. **Do not** use 409® cleaner or Armor All®.

5. Removable outside seat cushions should be placed inside when not in use.

Protect vinyl from being ripped or torn. Mildew, mold, pinking, yellowing, or other forms of staining can occur if vinyl is not cared for properly. Suntan lotion and insect repellents can also stain quickly and cause permanent damage.

1. Bird excreta & nausea stains: Sponge the area with soapy water containing diluted bleach until the stain is removed. Rinse thoroughly with water.
2. Urine stains: Sponge with soapy water containing a small amount of household ammonia. Rinse thoroughly with clean water.
3. Surface mildew: Wash with diluted bleach; use a soft brush for stubborn growth. Rinse with clear cold water.

WINDSCREENS

⚠ CAUTION

CAUTION: Never use acetone, benzene, carbon tetrachloride, lacquer thinner, or similar type solvents. They penetrate the surfaces and cause hazing which will obstruct visibility.

Plastic windscreens should be cleaned with clear water. After dirt is removed, use a plastic window cleaner and non-abrasive polish. Vibration may loosen windscreen fasteners during normal use. These should be checked periodically for tightness.

CARPETING

Exterior

Scrub carpeting with a brush using mild detergent and warm water, then thoroughly rinse with clear water. Allow carpet to dry completely before use. Apply a light coating of Scotch Guard® to protect against accidental spills.

CANVAS

Bimini-tops are designed and intended to provide coverage of the helm seating areas from the sun. These tops are not a weather cover. While these tops are intended to provide ample weather protection for the helm, the tops are not completely weather tight like a winter storage cover.

Cleaning

IMPORTANT: Do not use hot water, dry in an automatic dryer, dry clean or steam press canvas.

1. Wet down all canvas. Use a soft bristle brush and scrub with a mild detergent and water solution.
2. Use a mild solution of ammonia/water and scrub for heavy soil or mildew build-up. Be sure to rinse thoroughly.
3. Brush or sweep underside of the top. Spray with Lysol™ or other disinfectant to prevent mildew.

Care

1. Keep the top up in rain or when pontoon is not in use.
2. Lubricate zippers with paraffin, and snaps with petroleum jelly.

3. If a leak occurs along a canvas seam, rub with paraffin or apply a light coating of Scotch Guard®.
4. Air dry all canvas material before storing. Never store canvas while damp or wet, and provide proper ventilation to prevent mildew.
5. Avoid mooring under trees.
6. Never tow your pontoon with the top up.
7. When not in use, remove the top and store in the boot on board your pontoon.

Table of Contents

LINE DRAWINGS	i	PRE-LAUNCH & UNDERWAY (CONT.)	3
WELCOME ABOARD	1	Getting Underway	3.10
Owner's Manual Structure.....	1.1	Controls.....	3.11
Responsibilities	1.2	Starting Procedures	3.12
Pontoon Records	1.3	Trimming	3.14
Warranty.....	1.3	Additional Underway Information	3.15
Crestliner Pontoon Log (Form).....	1.4	Engine Shut Down	3.16
Crestliner Cruise Log (Form)	1.5	Reloading Your Pontoon.....	3.16
Crestliner Fuel Usage Log (Form).....	1.6	MAINTENANCE	4
Navigational Aids Chart	1.8	Service & Maintenance Schedule	4.1
Boating Safety.....	1.9	CARE & APPEARANCE	5
Safety Underway	1.12	Tube and Fence Care.....	5.1
Weather	1.15	Upholstery.....	5.2
Safety Equipment.....	1.16	Windshields and Windows	5.2
Additional Recommended Equipment.....	1.18	Carpeting	5.3
Boating Laws & Regulations	1.18	Canvas	5.3
Illegal to Dump	1.19	WINTERIZATION & STORAGE	6
SYSTEMS & COMPONENTS	2	Prior to Storage.....	6.1
Safety Labels	2.1 - 2.2	Engine.....	6.1
Systems	2.3	Livewell	6.2
Equipment.....	2.5	Interior Cleaning.....	6.2
Livewell	2.8	If You Store Your Pontoon on a Trailer	6.3
Seating.....	2.9	Recommissioning.....	6.3
Troubleshooting.....	2.10	PONTOON TERMINOLOGY	7
PRE-LAUNCH & UNDERWAY	3		
Trailerling	3.1		
Launching	3.2		
Loading	3.4		
Anchoring.....	3.6		
Fueling Recommendations	3.6		

This section of your owner's manual will assist you in preparing your pontoon for prolonged storage. When cold weather has arrived, or a change in your pontoons usage requires extended storage, we suggest you follow the guidelines contained within this section. For areas that do not require seasonal storage, Crestliner recommends a thorough annual inspection.

IMPORTANT: Consult your engine manual for specific instructions covering winterization of the engine. For recommended cleaning solutions and procedures referenced, see Section IV. Maintenance of your owner's manual.

PRIOR TO STORAGE

Tubes

1. Scrape off any barnacles or crusted marine growth.
2. Scrub the hull thoroughly to remove marine growth and scum.
3. Inspect the underwater gear and propellers for excessive wear or damage.
4. Remove the motor pod drain plug and store in a safe place (stern drive only).

Deck

1. Wash the deck, superstructure and cockpit.
2. Clean all deck hardware (i.e. cleats, rails, instruments, etc.) and apply a coat of metal polish or wax.
3. Clean the carpet.

ENGINE

1. Drain the engine block(s) and manifolds.
2. Drain the outdrive and change lubricant. (Your dealer will perform No. 1 and No. 2 for a moderate fee.)

IMPORTANT: In regions where temperatures fall below freezing, all engine plugs must be removed before storing your pontoon for the winter. Failure to do so will seriously damage the engine. Freeze damage is not covered by the Crestliner Warranty. Make sure your pontoon's engine is slightly bow up during the extended storage period.

Fuel System

Fill the fuel tank completely, or empty completely. Either method will minimize condensation. You may want to add a gasoline stabilizer solution to the fuel, if the tank is to remain full. Follow the product manufacturer's recommended procedure.

Engine Lubrication

1. Drain oil when engine is warm. This will ensure complete drainage of oil. If the engine oil contains sludge, use a flushing oil to clean away the residue. Refer to your engine manual.
2. Replace the engine oil filter.
3. Fill the crankcase(s) with the required quantity of recommended engine oil as specified in your engine manual.
4. Start the engine.

5. Pour or spray fogging oil through the carburetor air intake. Continue to pour or spray fogging oil until the engine stops.
6. Clean and lubricate all linkage.
7. Spray the entire exterior surface of the engine with a rust and corrosion inhibitor.
8. Have the engine alignment checked and adjusted by a qualified marine technician.
9. Inspect all gaskets and seals, grease the U-joints, and change gear oil.
10. Remove the propeller. Clean and lubricate the prop shaft and check for damage.

Battery

1. Remove battery, check water level, and store away from freezing temperatures.

IMPORTANT: Battery should be stored in a cool dry place.

⚠ WARNING

WARNING: To prevent personal injury, wear goggles, rubber gloves and a protective apron when working with battery. Battery electrolyte can cause severe eye damage and burns to the skin. In case of spillage, wash area with a solution of baking soda and water.

2. Clean outside battery case, terminals, and battery clamps with a solution of baking soda and water.

NOTE: Do not allow baking soda/water solution to enter the cells.

3. Lightly sand battery posts and clamps with fine grit emery cloth.
4. Apply a light coat of petroleum jelly to the cover end of the battery cables.
5. A monthly recharge or continuous trickle charge should be applied to the battery during storage.

LIVEWELL

1. Remove the drain tube from the drain in the livewell.
2. It is important to remove the water remaining in the hoses and pumps. Use a compressed air hose in all fittings and drain holes to remove all remaining water.

IMPORTANT: Failure to remove all water from the livewell system in freezing weather could result in component damage and/or leaks. This damage is not covered by the Crestliner Warranty.

INTERIOR CLEANING

1. Scrub all interior surfaces including cupboards, cabinets and drawers.
2. Be sure to remove everything that can hold moisture and cause mildew. Remove and store OFF the pontoon, all cushions, mattresses, towels, and clothing.
3. If it is necessary to store cushions on board:
 - Open all zippers and elevate cover away from the foam padding.
 - Place a small plastic bowl or other round blunt object inside the cushion to allow for adequate air circulation.

- Seats that can be folded should be stored in the down position.
 - Use plastic seat covers to keep out dampness and protect against mildew.
4. Personal flotation devices (PFDs) and other safety equipment must be cleaned and dried. If left on board, place them where air can circulate around them.
 5. Clean and thoroughly dry the bilge area. Remove all rags, sponges, or other cleaning materials from bilge area (stern drive only).
 6. Allow the interior to completely air out for a couple of days, weather permitting.
 7. If you store your pontoon outside, we recommend that you do not store it with the canvas and bow set on. Cover with a storage cover, tarp or plastic (available from Crestliner Dealers)-especially if you live in an area of heavy snow. Whatever material you use for a cover, be sure the pontoon is properly ventilated.

NOTE: After cleaning, make sure everything is thoroughly dry and air can circulate freely throughout the inside of your pontoon.

IF YOU STORE YOUR PONTOON ON A TRAILER

1. Loosen all tie-downs to relieve the stress on the tubes.
2. Place blocks under the axles if tires are to come in contact with damp ground.
3. Repack the trailer wheel bearings.

4. Store with the bow up, and remove the drain plug to allow for any excess water to drain.

RECOMMISSIONING

1. Inspect the fuel system and all associated equipment for proper connections, corrosion, leaks, or other damage. Always be alert for the odor of fuel vapors.

IMPORTANT: For detailed information concerning recommissioning of the engine, refer to your engine manual.

2. Clean battery terminal posts with a wire brush or steel wool before installing.
3. Check the charge on the battery. Recharge or replace if necessary.
4. Inspect all battery wiring. Repair or replace if necessary.
5. Attach the battery cables and tighten the cable clamps.

IMPORTANT: Do not apply petroleum jelly or marine grade grease before connecting and tightening clamps.

6. Apply petroleum jelly or marine grade grease on posts and clamps to eliminate air pockets and corrosion build up.
7. Coat the tube drain plug and bilge threads with petroleum jelly and reinstall (stern drive only).
8. Clean the bilge area (stern drive only).
9. Reinstall the exhaust drain plug (stern drive only).
10. Inspect all exhaust connections for carbon monoxide (CO) leakage. Adjust and repair as required (stern drive only).

11. Test the navigational lights and all other lighting on board.
12. Inspect all wiring for fraying, wear, loose connections, and other damage.
13. Inspect all switches, controls, and other related equipment for proper operation.
14. Inspect all safety equipment for proper operation and physical condition.

Abaft	Toward the stern.	Athwart	Across.
Abeam	Amidships, at a right angle to the keel.	Aweigh	Off the bottom, said of an anchor.
Aboard	On, in, or into a boat.	Aye	Yes, while aboard a vessel or ship. Means "I understand."
ABYC	American Boat and Yacht Council, Inc., the organization that sets voluntary safety and construction standards for small craft in the USA.	Bail (Bale)	To remove water from a vessel by pump or bailer.
Adrift	Without motive power and without anchor or mooring.	Ballast	Heavy material such as iron, lead, or stone placed in the bottom of the vessel.
Afloat	On the water.	Beacon	A post or buoy placed over a shoal or bank to warn vessels, also a signal mark on land.
Aft	Describing the after section of a vessel, or things to the rear of amidships and near the stern.	Beam	Imaginary line amidships at right angles to keel of vessel. Also vessel's width amidships.
Aground	Touching bottom.	Bearing	The direction or point of the compass in which an object is seen.
Amidships	In the center, the center portion of a vessel.	Belay	To make fast to a cleat or belaying pin; to cancel an order.
Anchor	A forging or casting shaped to grip the sea bottom and, by means of a cable or rope, hold a vessel in a desired position.	Bend	To fasten by means of a bend or knot.
Anchorage	A customary, suitable and (usually) designated harbor area in which vessels may anchor.	Berth	A position, as a place to sleep or in which a vessel may be made fast; a margin of safety, as "a wide berth."
Astern	Toward the stern. An object that is aft of a vessel is said to be astern of the vessel.	Bilge	The lower internal part of a vessel's hull.
		Bollard	A strong post for holding lines fast.

Bow The forward part or front of the vessel.

Breakers Waves cresting as they reach shallow water, as at or on a beach.

Breakwater A structure, usually stone or concrete, built to create a harbor or improve an existing one.

Bulkhead Vertical partition in a vessel.

Burdened Vessel Former term for the vessel which must stay clear of vessels with the right-of-way.

Calking (Caulking) Forcing filler material into the seams of the planks in a boat's deck or sides, to make them watertight.

Camber The arch of a deck, sloping downward from the center toward the sides.

Capsize To turn over.

Carburetor Backfire Flame Arrestor Required equipment on all motorboats except outboards and diesels. Reduces chance of fire caused by backfires in internal combustion engines.

Cardinal Points The four main points of a compass; north, east, south, and west.

Certificate Government paper, such as a vessel's license.

Chart A map of a body of water that contains piloting information.

Chine The intersection of sides and bottom of

a vessel.

Cleat A piece of wood or metal with projecting ends to which lines are made fast.

Coaming A raised edge, as around part or all of a cockpit, that prevents seawater from entering the boat.

Coast Guard The federal marine law enforcement and rescue agency in the US.

Cockpit A well or sunken space in the afterdeck of a small vessel for the use of the helmsman and crew.

Compass The instrument which shows the heading of a vessel.

Cradle A frame used to support a vessel on land.

Current The movement of the water in a horizontal direction.

Deadrise The rise of the bottom of a midships frame from the keel to the bilge.

Deck Any permanent covering over a compartment.

Deep-six To discard or throw overboard.

Depth Sounder An electronic depth-finding instrument, measuring the time a sound wave takes to go from the vessel to the bottom and return, then displaying the result in feet, fathoms, or meters.

Dinghy	A small, open boat.	Forward	Toward the bow.
Displacement Hull	Type of hull that plows through the water even when more power is added.	Freeboard	The vertical distance measured on a vessel's side from the waterline to the gunwale.
Dock	An enclosed or nearly enclosed water area; all the port installations; a place where vessels can moor, as a pier, wharf, or floating dock.	Galley	The kitchen area of a vessel.
Documented Vessel	Vessel registered with the U.S. Coast Guard.	Gimbals	Swivels used to keep equipment level.
Dolphin	A small group of piles, in the water, generally used for mooring or as a channel marker.	Give-Way Vessel	The one which must stay clear of vessels which have the right-of-way.
Draft	The depth of the vessel below the water line, measured vertically to the lowest part of the vessel.	Grab Rail	A convenient grip, on a cabin top or along a companion ladder.
Ebb	An outgoing tide.	Gunwale	The upper edge of a vessel's side. (pronounced gunnel.)
Estuary	An inlet or arm of the sea.	Harbor	A safe anchorage, protected from most storms; may be natural or man-made, with breakwaters and jetties; a place for docking and loading.
Fathom	Six feet.	Head	A marine toilet.
Fenders	Objects placed along the side of the vessel to protect the hull from damage.	Headway	Forward motion of a vessel through the water.
Flare	The outward spread of the vessel's sides from the waterline to the rail at the bow. Also, a pyrotechnic signaling device that can indicate distress.	Helm	The wheel or tiller by which a vessel is steered.
Fore	Used to distinguish the forward part of a vessel or things forward of amidships. It is the opposite of aft or after.	Holding Tank	Storage tank for sewage, so that it will not be pumped overboard into the water.
		Hypothermia	A physical condition where the body loses heat faster than it can produce it.

Inboard	More toward the center of a vessel; inside; a motor fitted inside the vessel.
Inland Rules	Rules of the road that apply to vessel operation in harbors and certain rivers, lakes, and inland waterways.
Intracoastal Waterways	(ICWs): bays, rivers and canals along the coasts (such as Atlantic and Gulf of Mexico coasts), connected so that vessels may travel without going into the open sea.
Jetty	A structure, usually masonry, projecting out from the shore; a jetty may protect a harbor entrance.
Keel	The permanently positioned, fore and aft backbone member of a vessel's hull.
Knot	To bend a line. Also, a unit of speed equal to one nautical mile (6,076.10 feet) an hour.
Launch	(1) To put a vessel into the water; (2) a small open powerboat, mainly used for transportation between a vessel and shore.
Lee	The side opposite to that from which the wind blows.
Leeward	Situated on the side turned away from the wind. (Opposite of windward.)
Leeway	The amount a vessel is carried sideways by the wind's force or current.

List	(1) A continuous leaning to one side, often caused by an imbalance in stowage or a leak into one compartment; (2) A light list is a printed listing of aids to navigation, in geographical order, or inclining of a vessel toward the side.
LOA	Length overall; the maximum length of a vessel's hull.
Locker	A storage place, a closet.
Log	A record or diary of a vessel's journey.
Lubber's Line	A mark or permanent line on a compass that shows the course of the vessel.
Making Way	Making progress through the water.
Marina	A place, essentially a dock area, where small recreational craft are kept; usually floats or piers, as well as service facilities, are available.
MAYDAY	A radio distress call, from the French m'aidez (help me); SOS in Morse Code.
Mooring	Commonly, the anchor chain, buoy, pennant, etc., by which a vessel is permanently anchored in one location.
Motor	A source of mechanical power.
Motorboat	Any watercraft 65 feet or less in length propelled by machinery, whether or not such machinery is the principal source of propulsion.

Navigation	The art of conducting a ship from port to port.	Pier	A structure, usually wood or masonry, extending into the water, used as a landing place for boats and ships.
Nautical Mile	6076.12 feet, or 1852 meters, an international standard; the geographical mile, the length of one minute of latitude at the equator, is 6087.20 feet.	Pile	A vertical wooden or concrete pole, driven into the bottom; may be a support for a pier or floats; also used for mooring.
Nun Buoy	A conical, red buoy bearing an even number and marking the starboard side of a channel from seaward.	Piling	A structure of piles.
Oar	A long, wooden instrument with a flat blade at one end, used for propelling a boat.	Pitch	(1) The up and down movement as the bow and stern rise and fall due to wave action; (2) The theoretical distance advanced by a propeller in one revolution.
Outboard	(1) a propulsion unit for vessels, attached at the transom; includes motor, drive shaft, and propeller; fuel tank and battery may be integral or installed separately in the boat; (2) outside or away from a vessel's hull; opposite of inboard.	Port	The left side of a watercraft when you are facing the bow, also a destination or harbor.
Outdrive	A propulsion system for vessels, with an inboard motor operating an exterior drive, with drive shaft, gears, and propeller; also called stern-drive and inboard/outboard.	Privileged Vessel	Former term for the vessel with the right-of-way.
Overall Length	The extreme length of a vessel, excluding spars or rigging fittings. See LOA.	Propeller	Wheel or screw. Mechanism that pushes water aft to propel the vessel.
Painter	A rope attached to the bow of a vessel for making it fast.	Rigging	The general term for all lines(ropes) of a vessel.
PFD	Personal Flotation Device.	Roll	The sideward motion of a vessel caused by wind or waves.
		Rules of the Road	The nautical traffic rules for preventing collisions on the water.
		Scope	The length of the anchor rope or chain. 6 to 1 scope means that the length of the anchor rope from the vessel to the anchor is 6 times the depth of the water.

Scupper A hole allowing water to run off the deck.

Sea Anchor A floating canvas cone, held open by wire rings, with an opening in the smaller end, and a rope bridle at the larger end attached to a line leading to the vessel; used in storm conditions to (a) keep the bow of the vessel to the wind, and (b) slow downwind drift of the boat.

Sea Cock A thru-hull valve, a shut-off on a plumbing or drain pipe between the vessel's interior and the sea.

Slip (1) a berth for a vessel between two piers or floats; (2) The percentage difference between the theoretical and the actual distance that a propeller advances when turning in water under load.

Sole The cabin or cockpit floor.

Spar Buoy A channel marker that looks like a tall, slender pole.

Stand-On Vessel The vessel with the right-of-way.

Starboard The right side of a watercraft when you are facing the bow.

Stern The after end or back of the watercraft.

Stow To store items neatly and securely.

Taffrail The rail around a vessel's stern.

Tide The alternate rise and fall of waters caused by the gravitational attraction of moon or sun.

Transom Back end of a watercraft. (Outboard motors are usually attached to a transom.)

Trim To arrange weights in a vessel in such a manner as to obtain desired draft at bow and stern.

Trimaran Vessel with three hulls, the center one is the largest.

Unbend To cast-off or untie.

Underway Vessel in motion, i.e., when not moored, at anchor or aground.

USPS United States Power Squadron, a private membership organization that specializes in boating education and good boating practices.

Vessel Every kind of watercraft, other than a seaplane on the water, capable of being used as a means of transportation on water.

VHF Radio A Very High Frequency electronic communications and direction finding system.

Wake Moving waves, created by watercraft motion. Track or path that a boat leaves behind it, when moving across the water.

Wash	The loose or broken water left behind a vessel as it moves along; the surging action of waves.
Waterline	The intersection of a vessel's hull and the water's surface; the line separating the bottom paint and the topsides.
Way	Movement of a vessel through the water. Technically it is underway when not at anchor, aground, or made fast to the shore. The common usage is interpreted as progress through the water. Headway when going forward and sternway when it is going backwards.
Well	Area at the rear of a vessel where the motor may be located.
Wharf	A structure, parallel to the shore, for docking vessels.
Wheel	(1) The steering wheel; (2) the propeller.
Whistle Signal	A standard communication signal between watercraft, to indicate change of course, danger, or other situations.
Windward	Situated on the side closest to the wind. (Opposite of leeward.)
Yaw	To swing or steer off course, as when running with a quartering sea.